

# Urethane Timing Belts and Pulleys





# Gates Mectrol

## Passion for Products

### **OUR EXPERTISE**

Gates Mectrol is a global manufacturer of belting and other automation components to the material handling industry. Our products are typically used in synchronous and positive drive conveying, linear positioning and power transmission applications within the general industrial and food processing markets.

Equipment designers and system integrators have come to rely on Gates Mectrol's application expertise and ability to solve the most challenging design issues. Our highly skilled applications engineers and online suite of design tools can help solve your most demanding development concerns.

Get the Gates Mectrol engineering team working for you.

### **OUR ACCESSIBILITY**

With manufacturing facilities and partner distributors located throughout the world, Gates Mectrol is available globally to serve your specific design challenges. Our associates know and understand our business — and yours.

### **OUR GOAL**

Gates Mectrol's goal is to become your primary supplier of polymer based automation components. We will earn this position by offering quality products in a timely manner and by continuously developing new products and services.

**IMAGINATION, DESIGN, EXECUTION**

# Urethane Timing Belts and Pulleys

## Table of Contents

Belt Selection Guide .....4

Tooth Pitch Comparison .....5

### Linear Belts

Linear Belt Overview .....6

Linear Belt Applications .....7

Linear Belt Specifications .....8

Imperial Pitch Belts .....10

T Pitch Belts .....11

AT Pitch Belts .....12

HTD® and STD Pitch Belts .....13

SelfTracking Belts .....14

Integral V-Guide Specifications .....16

Wide Belt Overview .....18

Wide Belt Applications .....19

Wide Belt Specifications .....21

Profiled Belts Overview .....22

Design Recommendations .....23

QuickShip Profile Program .....27

Backings .....28

Backings Specifications .....32

Fabrication Capabilities .....34

### Truly Endless Belts

Truly Endless Belt Overview .....36

Synchro-Power® (Cast) Belts .....37

Flex Belts .....41

### Flat Belts

Flat Belt Overview .....42

Flat Belt Specifications .....44

Design Recommendations .....45

### Timing Pulleys and Clamps

Pulley Overview .....46

Quick Ship Pulley Program .....47

Custom Pulley Program .....48

Pulley Bar Stock .....50

Clamp Plates .....51

### Food Grade Belts

Food Grade Belt Overview .....53

PosiClean® .....54

CenterClean™ .....55

FlatClean™ .....56

Food Belt Fastening Options .....57

Fabrication and Installation .....58

Sprockets and Support .....59

### Tools and Reference

Technical Design Tools Online .....60

Facilities .....61

Notes .....62

Contact Information .....64

## Broadest Range Available



# Belt Selection Guide

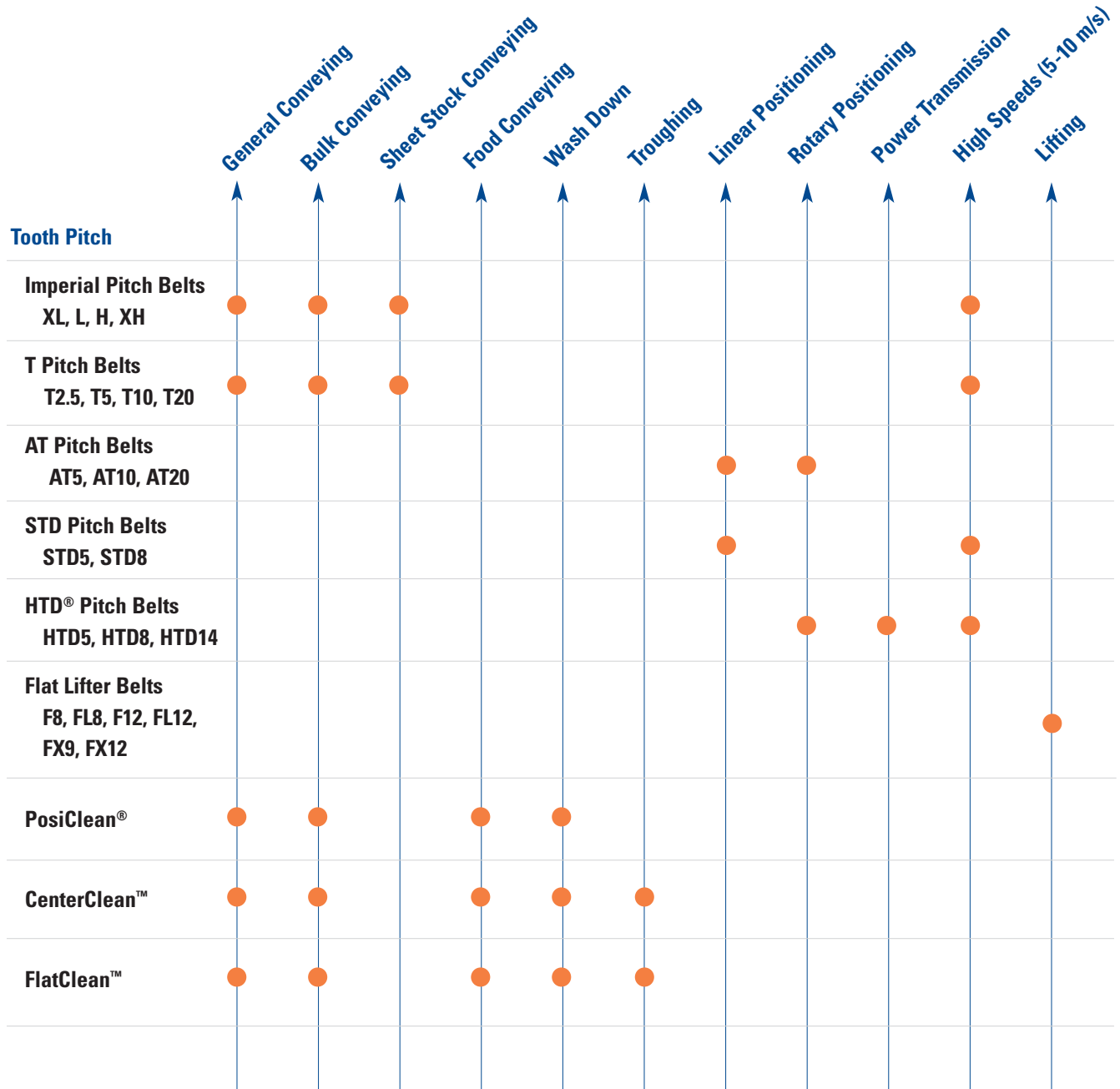

# Industrial Tooth Pitch Comparison

---

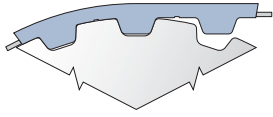

## Imperial Pitch Belts - XL, L, H, XH

This classic trapezoidal pitch is the original timing belt tooth design. This tooth pitch is commonly used for **conveying applications**. The tooth profile is fairly low and has a large surface area at the tip of the tooth providing good support on sliding conveyor surfaces.

---

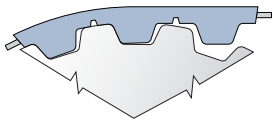

## T Pitch Belts - T2.5, T5, T10, T20

These metric trapezoidal pitches are similar to imperial pitches, also commonly used for **conveying applications**, yet have a slightly deeper tooth engagement than imperial profiles. The tooth meshing is more reliable. However, backlash can be slightly greater.

---

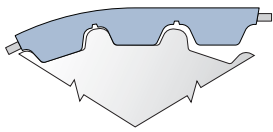

## AT Pitch Belts - AT5, AT10, AT20

This pitch was developed to enable higher load carrying capacity combined with low backlash. The stronger and stiffer tooth makes these belts ideal for **linear positioning and motion control**, but may require larger pulley diameters.

---

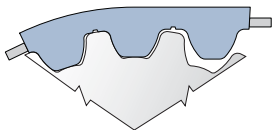

## STD Pitch Belts - STD5, STD8

This tooth pitch provides superior load distribution, low backlash, and **reduced wear and noise** characteristics. It is an excellent profile for **linear positioning and power transmission** applications.

---

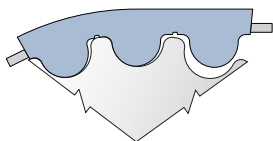

## HTD Pitch Belts - HTD5, HTD8, HTD14

This rounded tooth pitch is similar to STD, and is also an excellent profile for **linear and rotary positioning** and **power transmission** applications, yet has deeper tooth engagement. Note that the HTD pitch may exhibit slight increases in noise and wear.

# Linear Belt Overview

Gates Mectrol manufactures linear timing belts in a variety of tooth pitch, length, and material combinations. This offering provides a wide range of possible configurations for your application.

Linear belt lengths are available in two styles — welded endless and open ended. Welded endless belts are ideal for low torque conveying applications. Open ended belts are typically used for motion control applications.

## Features

- Very high tensile strength and stiffness
- Parallel cord construction
  - No cords exposed at belt edges
  - Better tracking
  - Uniform tensioning
- Tough polyurethane construction
  - Durable and cut resistant
  - Oil, chemical and water resistant
  - Non-marking
- Steel or Kevlar® tension members
- Choice of polymers including FDA grades
- Nylon back and nylon tooth surface options available for quieter operation and reduced friction
- Various molded profiles and backing materials available
- Wide range of tooth pitches to meet your application requirements

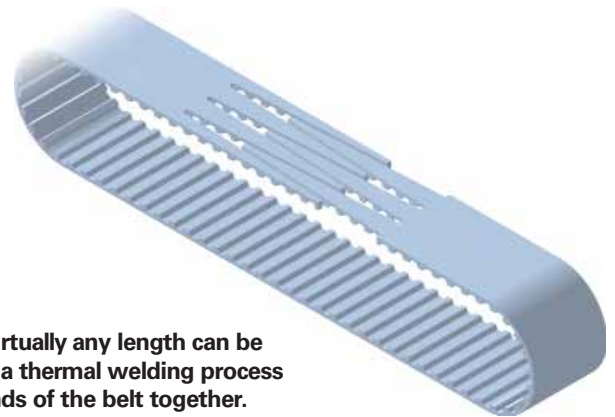

Endless belts of virtually any length can be produced utilizing a thermal welding process which joins the ends of the belt together.

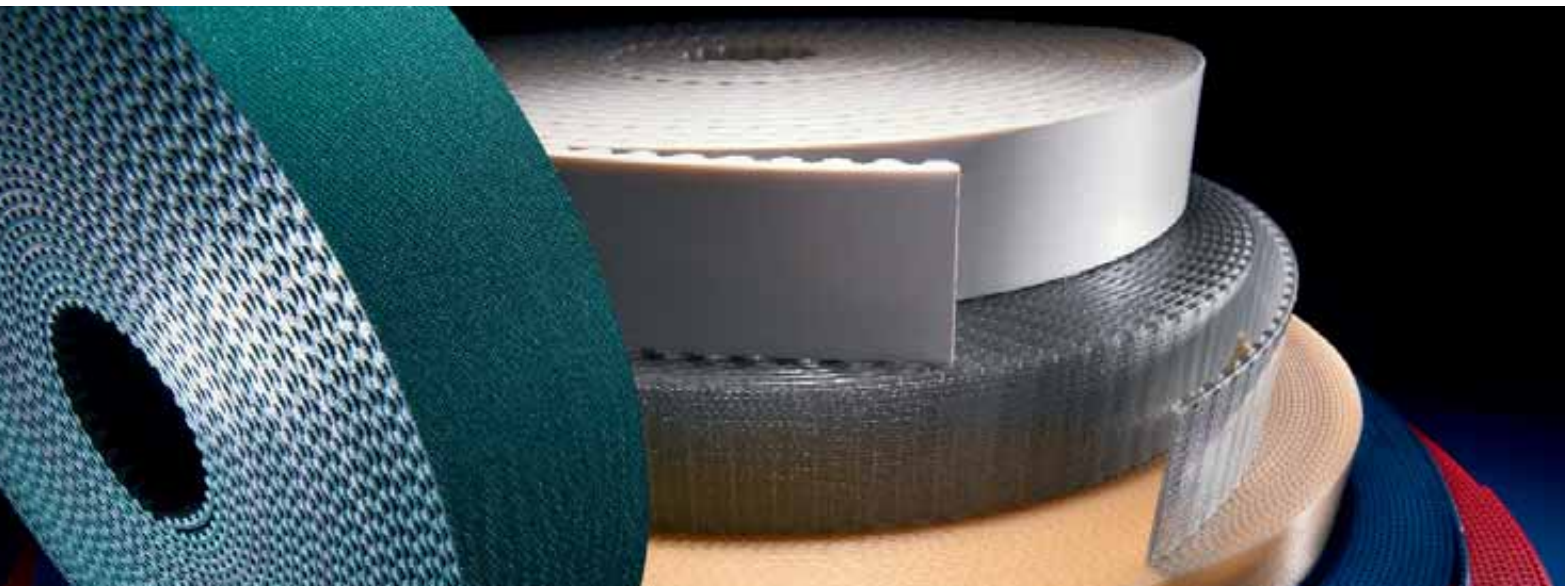

# Linear Belt Applications

## Application Characteristics

- High precision positioning or indexing
- Synchronous conveying
- High acceleration, deceleration or continuous high running speeds
- Multiple belt, common shaft conveying
- Customized belts to meet any application need

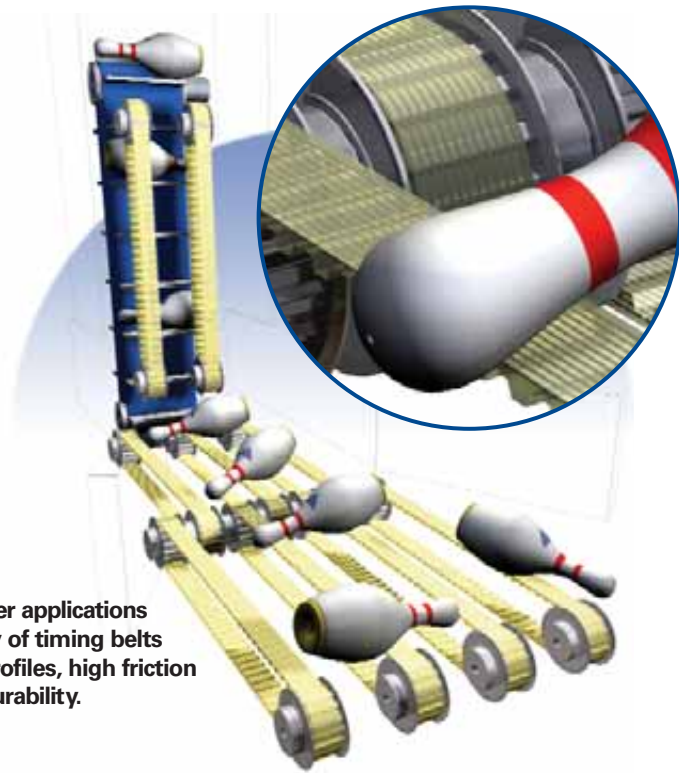

Bowling pinsetter applications require a variety of timing belts with different profiles, high friction backings, and durability.



Urethane timing belts are ideal for use in vertical and horizontal door applications. Durable and clean running, these belts provide quiet and positive motion for industrial, train, elevator, and automatic slide door applications.



Rough Top backing on urethane timing belts allows synchronous conveying of sheet glass without interference from glass shards.

>> Our Applications Engineering staff is available to you at [apps@gatesmectrol.com](mailto:apps@gatesmectrol.com) or **1-800-394-4844**

# Linear Belt Specifications

			XL	L	H	H-HF	XH	T5	AT5	ATL5	
<b>Pitch (Imperial and Metric)</b>			<b>.200"</b>	<b>.375"</b>	<b>.500"</b>	<b>.500"</b>	<b>.875"</b>	<b>5 mm</b>	<b>5 mm</b>	<b>5 mm</b>	
Ultimate Tensile Strength per Inch or 25 mm Belt Width	Steel	lbf/in	759	1474	1605	2369	3204	759	1602	2369	
		N/25 mm	3375	6555	7140	10540	14250	3375	7125	10540	
	Kevlar	lbf/in	1882	1727	1818	N/A	3639	1200	1877	N/A	
		N/25 mm	8370	7682	8085	N/A	16185	5332	8350	N/A	
	Stainless Steel	lbf/in	N/A	N/A	N/A	N/A	N/A	N/A	N/A	N/A	
		N/25 mm	N/A	N/A	N/A	N/A	N/A	N/A	N/A	N/A	
Max. Allowable Belt Tension per Inch or 25 mm Belt Width	Steel	Open Ended	lbf/in	192	371	436	534	854	189	396	526
			N/25 mm	853	1652	1939	2377	3801	840	1761	2340
		Welded	lbf/in	96	186	218	267	427	94	198	198
			N/25 mm	427	826	970	1189	1900	420	880	880
	Kevlar	Open Ended	lbf/in	209	276	243	N/A	400	180	272	N/A
			N/25 mm	930	1229	1081	N/A	1778	801	1210	N/A
		Welded	lbf/in	157	207	182	N/A	300	140	204	N/A
			N/25 mm	698	922	810	N/A	1334	687	908	N/A
	Stainless Steel	Open Ended	lbf/in	N/A	N/A	N/A	N/A	N/A	N/A	N/A	N/A
			N/25 mm	N/A	N/A	N/A	N/A	N/A	N/A	N/A	N/A
		Welded	lbf/in	N/A	N/A	N/A	N/A	N/A	N/A	N/A	N/A
			N/25 mm	N/A	N/A	N/A	N/A	N/A	N/A	N/A	N/A
Allowable Effective Tension for Belt Teeth (15 and more teeth in mesh)			lbf/in	180	360	441	441	879	200	290	290
			N/25 mm	800	1600	1960	1960	3910	890	1290	1290
Specific Belt Weight	Steel	lbf/ft/in	0.036	0.059	0.066	0.072	0.180	0.037	0.055	0.062	
		kgf/m/cm	0.021	0.035	0.039	0.042	0.105	0.022	0.032	0.036	
	Kevlar	lbf/ft/in	0.033	0.052	0.055	N/A	0.155	0.033	0.046	N/A	
		kgf/m/cm	0.019	0.030	0.032	N/A	0.091	0.020	0.027	N/A	
	Stainless Steel	lbf/ft/in	N/A	N/A	N/A	N/A	N/A	N/A	N/A	N/A	
		kgf/m/cm	N/A	N/A	N/A	N/A	N/A	N/A	N/A	N/A	
Specific Belt Stiffness (Open Ended)	Steel	lbf/in	47950	92800	109000	133600	213600	47950	100500	133600	
		N/mm	8400	16255	19085	23400	37410	8400	17605	23400	
	Kevlar	lbf/in	52250	69100	60700	N/A	100000	52250	69100	N/A	
		N/mm	9155	12100	10635	N/A	17500	9155	12100	N/A	
	Stainless Steel	lbf/in	N/A	N/A	N/A	N/A	N/A	N/A	N/A	N/A	
		N/mm	N/A	N/A	N/A	N/A	N/A	N/A	N/A	N/A	
Min. No. of Pulley Teeth	Steel and Kevlar		10	10	14	12	18	10	15	15	
	Stainless Steel		N/A	N/A	N/A	N/A	N/A	N/A	N/A	N/A	
Min. Pitch Diameter (Inch or mm)	Steel and Kevlar		inch or mm	.64"	1.19"	2.23"	1.91"	5.01"	16 mm	24 mm	24 mm
	Stainless Steel		mm	N/A	N/A	N/A	N/A	N/A	N/A	N/A	N/A
Min. Diameter of Tensioning Idler Running on Back of Belt	Steel and Kevlar		in/mm	1.125"/30 mm	2.375"/60 mm	3.125"/80 mm	2.375"/60 mm	5.875"/150 mm	1.125"/30 mm	2.375"/60 mm	2.375"/60 mm
	Stainless Steel		in/mm	N/A	N/A	N/A	N/A	N/A	N/A	N/A	N/A
Available in FDA Compliant Construction (85 Shore A Urethane)			Yes	Yes	Yes			Yes			
Standard Colors (N=Natural, W=White)			N	N	N,W	N	N	N,W	W	W	

## Calculating Belt Weight

### Imperial Units

$$\text{Belt Weight} = (\text{Specific Belt Wt, lbf/ft/in}) \times (\text{Belt Length, ft}) \times (\text{Belt Width, in})$$

e.g. 200 ft of H600, Steel Cord

$$\text{Belt Weight} = 79 \text{ lbs} = (0.066 \text{ lbf/ft/in}) \times (200 \text{ ft}) \times (6 \text{ in})$$

### Metric Units

$$\text{Belt Weight} = (\text{Specific Belt Wt, kgf/m/cm}) \times (\text{Belt Length, m}) \times (\text{Belt Width, cm})$$

e.g. 100 meters of 150T10, Steel Cord

$$\text{Belt Weight} = 111 \text{ kg} = (0.074 \text{ kgf/m/cm}) \times (100 \text{ m}) \times (15 \text{ cm})$$

### Service Temperature Range

-5° C to 70° C (23° F to 158° F)

### Hardness

92 Shore A - Standard PU, 85 Shore A - FDA Compliant PU

### Coefficient of Friction

Urethane vs. UHMWPE (dry)

Urethane vs. Steel (dry)	0.5 to 0.7
Urethane vs. Aluminum (dry)	0.5 to 0.6
Urethane vs. UHMWPE (dry)	0.2 to 0.4
Nylon vs. Steel (dry)	0.2 to 0.4
Nylon vs. UHMWPE (dry)	0.1 to 0.3



T10	T10-HF	AT10	ATL10	ATL10-HF	T20	AT20	ATL20	HTD5	HTD8	HTD14	HTDL14	STD5	STD8
10 mm	10 mm	10 mm	10 mm	10 mm	20 mm	20 mm	20 mm	5 mm	8 mm	14 mm	14 mm	5 mm	8 mm
1605	2369	3204	5445	6059	3204	5445	7913	2369	3204	4667	7848	2369	3204
7140	10540	14250	24220	26950	14250	24220	35200	10540	14250	20760	34909	10540	14250
1818	N/A	3639	N/A	N/A	3639	4900	N/A	1818	3639	4200	N/A	1818	3639
8085	N/A	16185	N/A	N/A	16185	21798	N/A	8085	16185	18684	N/A	8085	16185
N/A	N/A	2403	N/A	N/A	2403	N/A	N/A	N/A	2403	N/A	N/A	N/A	N/A
N/A	N/A	10687	N/A	N/A	10687	N/A	N/A	N/A	10687	N/A	N/A	N/A	N/A
429	526	841	1317	1142	841	1317	1732	526	841	1159	1718	526	841
1908	2340	3741	5860	5079	3741	5860	7705	2340	3741	5156	7641	2340	3741
215	263	421	421	421	421	659	N/A	263	421	580	N/A	263	421
954	1170	1870	1870	1870	1870	2930	N/A	1170	1870	2578	N/A	1170	1870
239	N/A	393	N/A	N/A	393	393	N/A	239	393	341	N/A	239	393
1063	N/A	1750	N/A	N/A	1750	1750	N/A	1063	1750	1515	N/A	1063	1750
179	N/A	295	N/A	N/A	295	295	N/A	179	295	255	N/A	179	295
797	N/A	1312	N/A	N/A	1312	1312	N/A	797	1312	1136	N/A	797	1312
N/A	N/A	631	N/A	N/A	631	N/A	N/A	N/A	631	N/A	N/A	N/A	N/A
N/A	N/A	2805	N/A	N/A	2805	N/A	N/A	N/A	2805	N/A	N/A	N/A	N/A
N/A	N/A	315	N/A	N/A	315	N/A	N/A	N/A	315	N/A	N/A	N/A	N/A
N/A	N/A	1402	N/A	N/A	1402	N/A	N/A	N/A	1402	N/A	N/A	N/A	N/A
380	380	580	580	580	710	1221	1221	229	420	771	771	220	409
1690	1690	2580	2580	2580	3160	5430	5430	1020	1870	3430	3430	980	1820
0.074	0.079	0.096	0.114	0.118	0.125	0.169	0.185	0.07	0.101	0.182	0.21	0.067	0.087
0.043	0.046	0.056	0.067	0.069	0.073	0.099	0.108	0.041	0.059	0.107	0.123	0.039	0.051
0.062	N/A	0.071	N/A	N/A	0.101	0.124	N/A	0.05	0.08	0.143	N/A	0.05	0.074
0.036	N/A	0.042	N/A	N/A	0.059	0.073	N/A	0.029	0.047	0.084	N/A	0.029	0.043
N/A	N/A	0.096	N/A	N/A	0.125	N/A	N/A	N/A	0.101	N/A	N/A	N/A	N/A
N/A	N/A	0.056	N/A	N/A	0.073	N/A	N/A	N/A	0.059	N/A	N/A	N/A	N/A
109000	133600	213600	334600	290000	213600	334600	440000	133600	213600	294400	440000	133600	213600
19085	23400	37410	58600	50790	37410	58600	77050	23400	37410	51560	77050	23400	37410
60700	N/A	100000	N/A	N/A	100000	100000	N/A	60700	100000	86500	N/A	60700	100000
10635	N/A	17500	N/A	N/A	17500	17500	N/A	10635	17500	15150	N/A	10635	17500
N/A	N/A	160212	N/A	N/A	160212	N/A	N/A	N/A	160212	N/A	N/A	N/A	N/A
N/A	N/A	28057	N/A	N/A	28057	N/A	N/A	N/A	28057	N/A	N/A	N/A	N/A
14	12	15	25	20	15	18	30	14	20	28	43	14	20
N/A	N/A	20	N/A	N/A	20	N/A	N/A	N/A	25	N/A	N/A	N/A	N/A
45 mm	38 mm	48 mm	80 mm	64 mm	96 mm	115 mm	191 mm	22 mm	51 mm	125 mm	191 mm	22 mm	51 mm
N/A	N/A	64 mm	N/A	N/A	127 mm	N/A	N/A	N/A	64 mm	N/A	N/A	N/A	N/A
3.125"/80 mm	2.375"/60 mm	4.75"/120 mm	5.875"/150 mm	5.125"/130 mm	4.75"/120 mm	7.125"/180 mm	9.875"/250 mm	2.375"/60 mm	4.75"/120 mm	7.875"/200 mm	9.875"/250 mm	2.375"/60 mm	4.75"/120 mm
N/A	N/A	6.25"/160 mm	N/A	N/A	6.25"/160 mm	N/A	N/A	N/A	6.00"/150 mm	N/A	N/A	N/A	N/A
Yes													
N,W	N	W	W	W	N,W	W	W	W	W	W	W	W	W

The specifications listed are based on Gates Mectrol's experience. However, our specifications and data do NOT cover all possible belt drive conditions. It is the responsibility of the belt drive system designer to ensure Gates Mectrol's belts are appropriate for a given system and application. The provided data is representative of our in-house experience and does not necessarily match product performance in industrial use. Gates Mectrol cannot assume any liability concerning the suitability and process ability of our products. We also cannot assume liability for process results, damages or consequential damages associated with the use of our products. Note, ultimate tensile strengths are listed for references purposes only. Ultimate tensile strength values listed above are a theoretical calculation based on average cord strength and may not represent actual tensile test results.

- HF designates high flex cords.
- Most belts are available with Nylon Fabric on either or both sides.  
 For Nylon on the tooth side, specify "NT"  
 For Nylon on the back side, specify "NB"  
 For Nylon on both sides, specify "NTB"  
 Note: Nylon on tooth side is NOT available on HTD5 Steel or Kevlar in widths greater than 50 mm.
- Belting produced to specific length tolerance is available upon request.
- Many linear positioning applications require belts of a specific length tolerance, or a "minus pitch tolerance."  
 Gates Mectrol can produce belts to specific minus tolerances. Consult a Gates Mectrol Applications Engineer to determine the proper length tolerance calculation.

# Imperial Pitch Belts

XL .200" Pitch

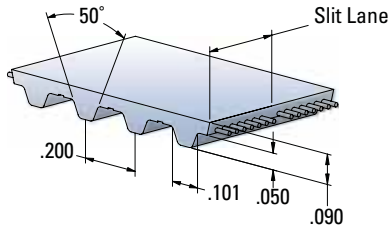

		XL	L	H*, H-HF*	XH
Min. Welded Belt Length	inch	17	17	17 (4" wide) 33.5 (6" wide)	40.25
	feet	200	200	200	100
Standard Roll Lengths	meters	61	61	61	30
	inch	1/4	1/2	1.0	1.0
Standard Slitting Lanes	inch	1/4	1/2	1.0	1.0
Available Slitting Lanes	inch	N/A	N/A	3/4	N/A

All roll lengths are ±1%.  
\*Heavy Back (HB) option available.

L .375" Pitch

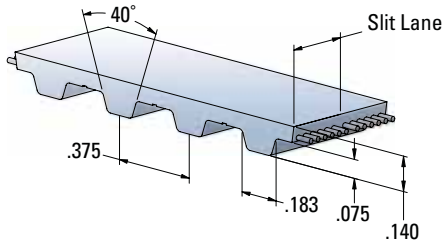

### Available Widths

Code	inch	mm	XL	L	H, H-HF	XH
025	1/4	6.35	X			
031	5/16	7.94	X			
037	3/8	9.53	X	X	X	
050	1/2	12.7	X	X	X	X
075	3/4	19.05	X	X	X	X
100	1	25.4	X	X	X	X
150	1 1/2	38.1	X	X	X	X
200	2	50.8	X	X	X	X
300	3	76.2		X	X	X
400	4	101.6		X	X	X
600	6	152.4			X	X

All belts are available in any width between the minimum and maximum listed width.

H, H-HF .500" Pitch  
WH .500" Pitch—From 6" to 18" wide

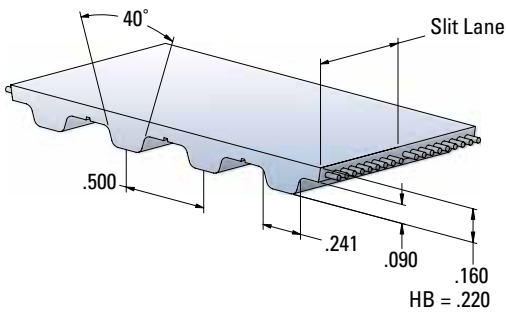

### Width Tolerances

Width	XL	L	H, H-HF	XH
Up to 2"	± .020"	± .020"	± .020"	± .040"
> 2" - 4"	N/A	± .030"	± .030"	± .040"
> 4" - 6"	N/A	N/A	± .030"	± .040"

XH .875" Pitch

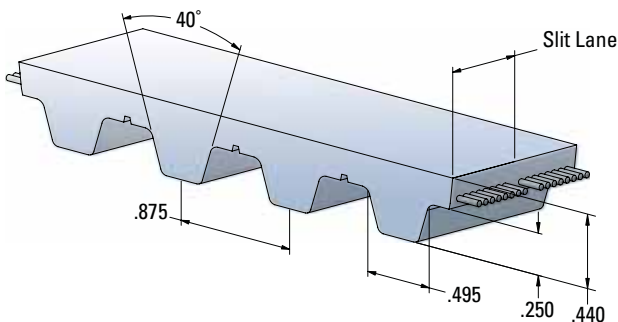

### To Order Imperial Pitch Belts

600 H 200 ( ) ( )  
 Insert "NT" for Nylon Teeth, "NB" for Nylon Back, "NTB" for Nylon on Both Sides, "HB" for Heavy Backing, "FDA" for FDA  
 Insert "K" if specifying Kevlar  
 Width: 2.0" x 100 = 200  
 Pitch: H (1/2")  
 Length: 60.0" x 10 = 600

# T Pitch Belts

## T5 5 mm Pitch

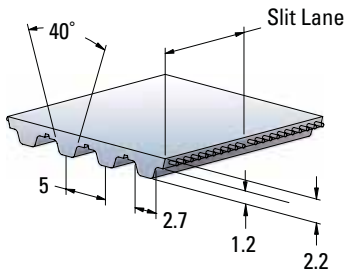

## T10, T10-HF 10 mm Pitch WT10 10 mm Pitch from 150 to 450 mm wide

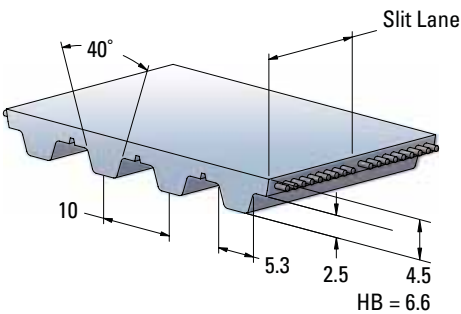

## T20 20 mm Pitch

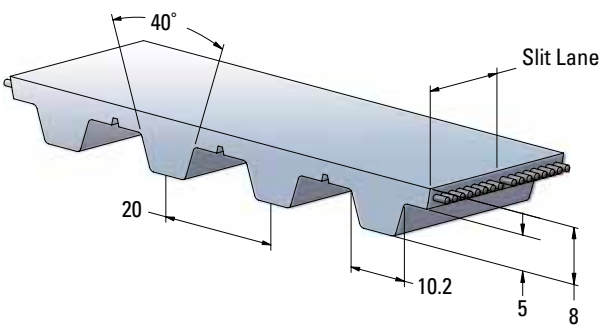

		T5	T10*, T10-HF*	T20
Min. Welded Belt Length	mm	440 (50 mm wide) 450 (100 mm wide)	450 (100 mm wide) 850 (150 mm wide)	1000
Standard Roll Lengths	meters	100	100	50
Standard Slitting Lanes	mm	25	25	25
Available Slitting Lanes	mm	10, 16	16, 32	N/A

All roll lengths are ±1%.

\*Heavy Back (HB) option available.

### Available Widths

mm	T5	T10, T10-HF	T20
6	X		
10	X	X	
12	X	X	
16	X	X	
20	X	X	
25	X	X	X
32	X	X	X
50	X	X	X
75	X	X	X
100	X	X	X
150		X	X

All belts are available in any width between the minimum and maximum listed width.

### Width Tolerances

Width	T5	T10, T10-HF	T20
Up to 50 mm	±0.5 mm	±0.5 mm	± 1.0 mm
> 50-100 mm	±0.75 mm	±0.75 mm	± 1.0 mm
> 100-150 mm	N/A	±0.75 mm	± 1.0 mm

### To Order T Pitch Belts

50 T10 1080 ( ) ( )

Insert "NT" for Nylon Teeth, "NB" for Nylon Back, "NTB" for Nylon on Both Sides, "HB" for Heavy Backing, "FDA" for FDA

Insert "K" if specifying Kevlar

Length: 1080 (108 Teeth x 10 mm)

Pitch: T10 (10 mm)

Width: 50 mm

# AT Pitch Belts

## AT5 and ATL5 5 mm Pitch

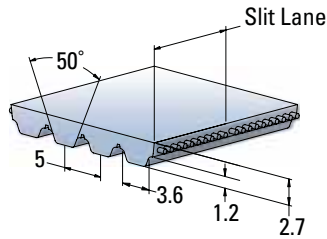

		AT5	ATL5	AT10	ATL10, ATL10-HF	AT20, ATL20
Min. Welded Belt Length	mm	440	450	460 (100 mm wide) 860 (150 mm wide)	900	1000
Standard Roll Lengths	meters	100	100	100	100	50
Standard Slitting Lanes	mm	25	25	25	25	N/A
Available Slitting Lanes	mm	10, 16	16	N/A	N/A	N/A

All roll lengths are  $\pm 1\%$ .

## AT10, ATL10, and ATL10-HF 10 mm Pitch

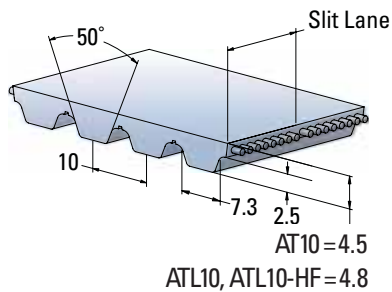

### Available Widths

mm	AT5	ATL5	AT10, ATL10, ATL10-HF	AT20, ATL20
6	X			
10	X	X		
12	X	X		
16	X	X	X	
20	X	X	X	
25	X	X	X	X
32	X	X	X	X
50	X	X	X	X
75	X	X	X	X
100	X	X	X	X
150		X	X	X

All belts are available in any width between the minimum and maximum listed width.

## AT20 and ATL20 20 mm Pitch

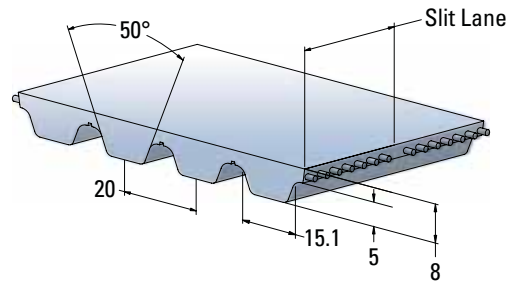

### Width Tolerances

Width	AT5	ATL5	AT10	ATL10, ATL10-HF	AT20	ATL20
Up to 50 mm	$\pm 0.5$ mm	$\pm 0.5$ mm	$\pm 0.75$ mm	$\pm 1.0$ mm	$\pm 1.0$ mm	$\pm 2.0$ mm
> 50-100 mm	$\pm 0.75$ mm	$\pm 0.75$ mm	$\pm 1.0$ mm	$\pm 1.5$ mm	$\pm 1.5$ mm	$\pm 2.0$ mm
> 100-150 mm	N/A	$\pm 0.75$ mm	$\pm 1.0$ mm	$\pm 1.5$ mm	$\pm 1.5$ mm	$\pm 2.0$ mm

### To Order AT Pitch Belts

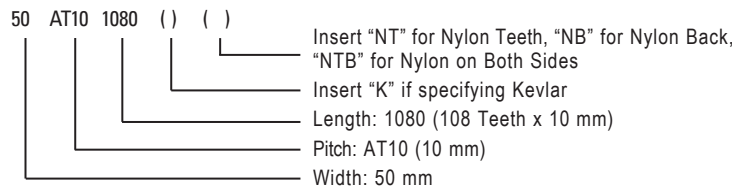

# HTD<sup>®</sup> and STD Pitch Belts

HTD5 5 mm Pitch

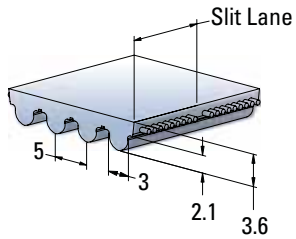

HTD8 8 mm Pitch

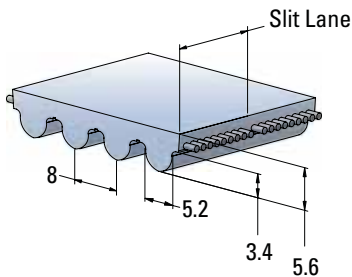

HTD14, HTDL14 14 mm Pitch

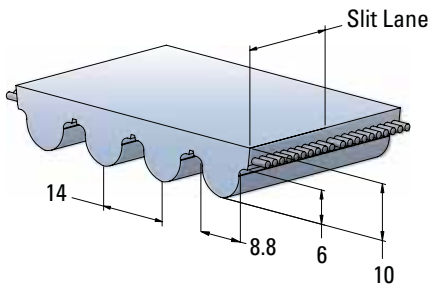

STD5 5 mm Pitch

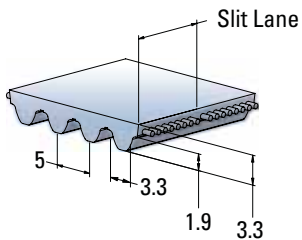

STD8 8 mm Pitch

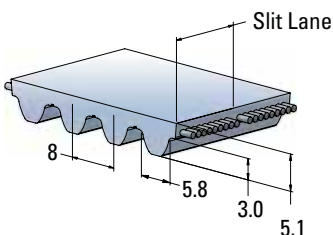

		HTD5	HTD8	HTD14, HTDL14	STD5	STD8
Min. Welded Belt Length	mm	450	456	1000	450	456
Standard Roll Lengths	meters	100	100	50	100	100
Standard Slitting Lanes	mm	25	No Slit Lane	55	25	No Slit Lane
Available Slitting Lanes	mm	15	20, 25, 30	85	10, 15	25

All roll lengths are ±1%.

### Available Widths

mm	HTD5	HTD8	HTD14, HTDL14	STD5	STD8
5	X			X	
10	X	X		X	X
15	X	X		X	X
20		X			X
25	X	X	X	X	X
30		X			X
40			X		
50	X	X		X	X
55			X		
85	X*	X	X		X
100	X*	X	X		X
115			X		
150	X*	X**			
170			X		

All belts are available in any width between the minimum and maximum listed width.

\* These widths are only available in HTD5 Steel or HTD5 Steel with NB.

\*\* This width is not available in HTD8 Kevlar.

### Width Tolerances

Width	HTD5	HTD8	HTD14, HTDL14	STD5	STD8
Up to 50 mm	±0.5 mm	±0.75 mm	±1.0 mm	±0.5 mm	±0.75 mm
> 50-100 mm	±0.75 mm	± 1.0 mm	±1.5 mm	N/A	± 1.0 mm
> 100-150 mm	±0.75 mm	± 1.0 mm	±2.0 mm	N/A	N/A
> 150-170 mm	N/A	N/A	±2.0 mm	N/A	N/A

### To Order HTD and STD Pitch Belts

25 HTD5M 1000 ( ) ( )

- Insert "NT" for Nylon Teeth, "NB" for Nylon Back, "NTB" for Nylon on Both Sides
- Insert "K" if specifying Kevlar
- Length: 1000 mm
- Pitch: HTD5 (5 mm)
- Width: 25 mm

# Self Tracking Belts

## Notched V-Guide – Allows Maximum Flexibility

Gates Mectrol self tracking timing belts have all the capabilities of standard urethane timing belts but utilize guides to eliminate any lateral movement. Our range of specially designed urethane V-guides are notched along the belt length to provide optimum flexibility around pulleys.

Gates Mectrol manufactures V-guided belts in two constructions — **fabricated**, any of four V-guides can be added to any pitch belt in any width, length combination, or — **integral**, the V-guide is integrally molded to specific belt pitches for greater strength and consistency.

### Features

- V-guides can be added to virtually any of our belts, eliminating the need for flanged pulleys
- Notched construction for extra flexibility around tight belt paths
- Produced with the same durable urethane as the base belt
- Different sizes available to serve any application requirement
- Integrally produced with the belt for durability or fabricated to fit onto our existing belts

## Fabricated V-Guides

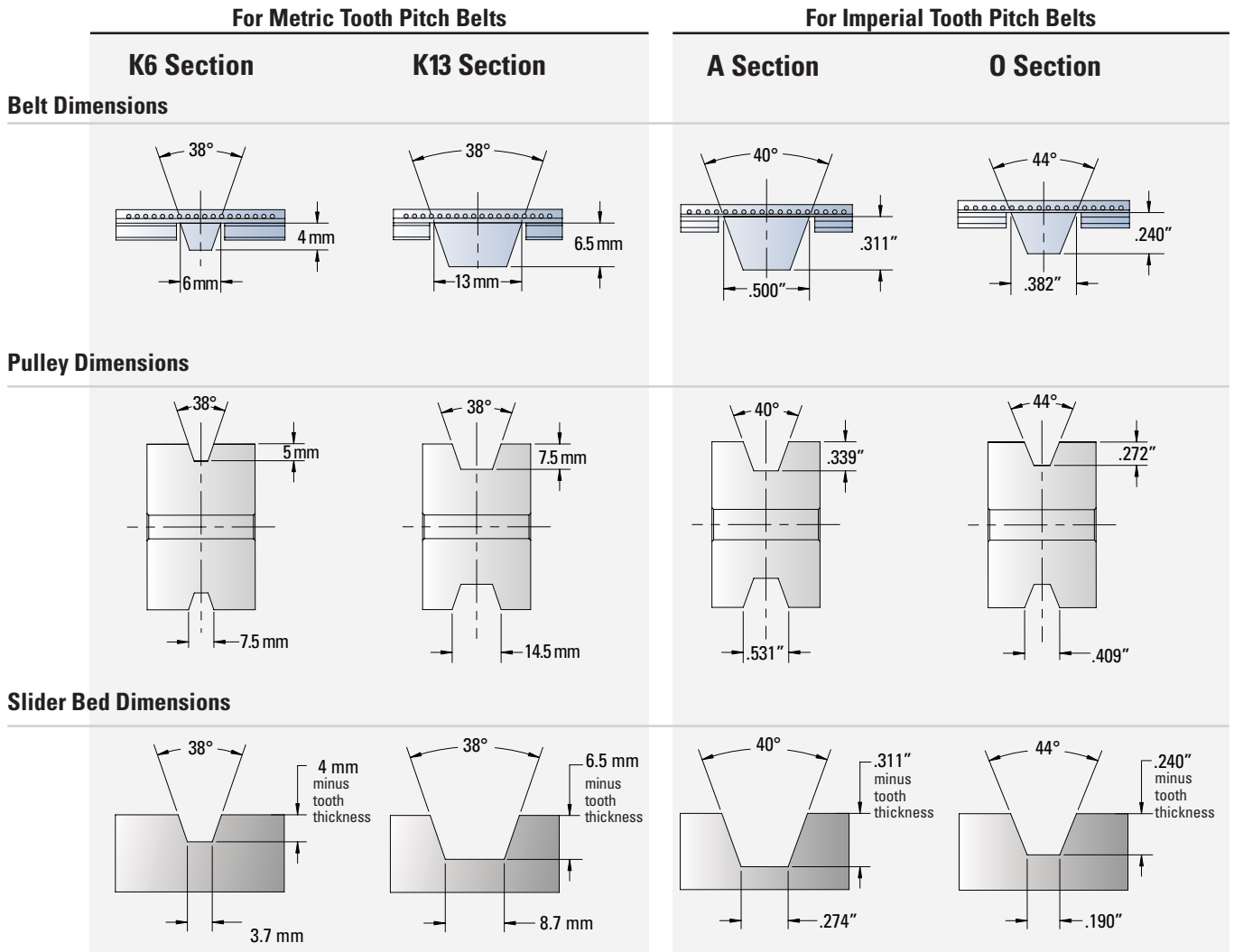

### Application Characteristics

- Long length conveying or linear positioning where tracking is an issue
- Conveying applications where design considerations prevent the use of pulley flanges
- Reduce or eliminate any belt “wander” by providing continuous guiding along conveyor length

### Integral V-Guides

		T5V	T10VS	T10V	AT5V	ATL5V	AT10V	HV
Min. Welded Belt Length	inch							36
	mm	920	900	900	900	N/A	950	
Standard Roll Length	feet							200
	meters	100	100	100	100	100	100	
Standard Slitting Lanes	inch							1
	mm	25	25	25	25	25	25	

All roll lengths are ±1%.

### Width Tolerances

Width	T5V	T10VS	T10V	AT5V	ATL5V	AT10V	HV
Up to 50 mm Up to 2"	±0.5 mm	±0.5 mm	±0.5 mm	±0.5 mm	±0.5 mm	±0.75 mm	±0.020 in
>50 - 100 mm >2" - 4"	±0.75 mm	N/A	±0.75 mm	N/A	N/A	±1.0 mm	±0.030 in
>100 mm - 150 mm >4" - 6"	N/A	N/A	±0.75 mm	N/A	N/A	±1.0 mm	±0.030 in

T5V (K6 Section)

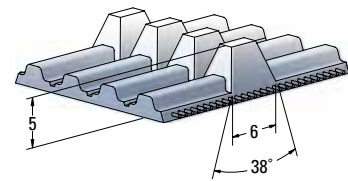

Available widths  
– 16, 25, 32, 50, 75, 100 mm

AT5V, ATL5V (K6 Section)

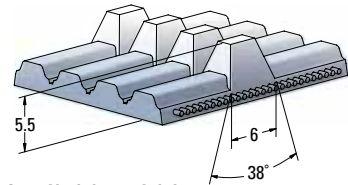

Available widths  
– 16, 25, 32, 50 mm

T10VS (K6 Section)

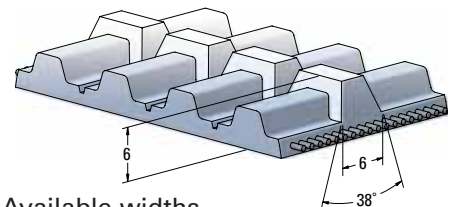

Available widths  
– 16, 25, 32, 50 mm

T10V (K13 Section)

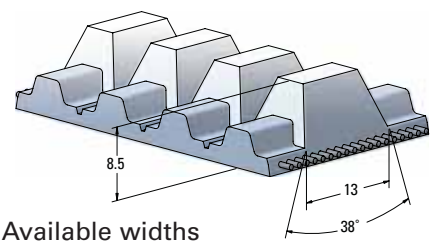

Available widths  
– 25, 32, 50, 75, 100, 150 mm

AT10V (K13 Section)

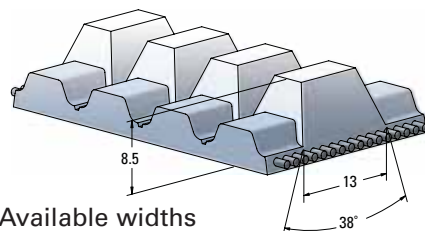

Available widths  
– 25, 32, 50, 75 mm

HV (A Section)

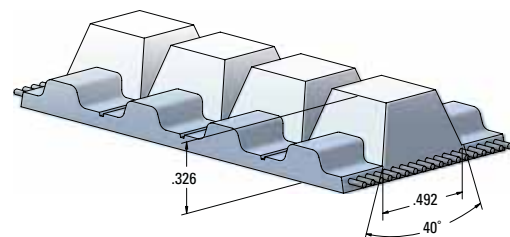

Available widths  
– 1.5, 2, 3, 4, 6 inch

# Integral V-Guide Belt Specifications

		HV					T5V							
Pitch (Imperial and Metric)		.500"					5 mm							
Belt Width		1.5"	2"	3"	4"	6"	16 mm	25 mm	32 mm	50 mm	75 mm	100 mm		
Ultimate Tensile Strength	Steel	lbf	2455	3305	5004	6704	10103	450	759	955	1546	2332	3119	
		N	10920	14700	22260	29820	44940	2000	3375	4250	6875	10375	13875	
	Kevlar	lbf	2787	4241	6422	8603	12965	1115	1882	2369	3833	5784	7736	
		N	12397	18865	28567	38269	57673	4960	8370	10540	17050	25730	34410	
Max. Allowable Belt Tension	Steel	Open Ended	lbf	667	897	1338	1792	2700	112	189	238	385	581	776
			N	2966	3992	5950	7971	12012	498	840	1058	1711	2582	3453
		Welded	lbf	255	322	547	775	1225	52	80	98	179	264	340
			N	1135	1432	2434	3447	5449	232	356	438	796	1173	1512
	Kevlar	Open Ended	lbf	372	478	724	970	1462	122	206	259	419	633	846
			N	1657	2127	3221	4315	6503	543	916	1153	1865	2814	3764
		Welded	lbf	213	269	457	648	1024	52	80	98	179	264	340
			N	949	1197	2035	2882	4555	232	356	438	796	1173	1512
Allowable Effective Tension for Belt Teeth (15 and More Teeth in Mesh)		lbf	444	664	1105	1546	2427	80	152	208	352	552	752	
		N	1976	2956	4916	6876	10796	356	676	926	1566	2456	3346	
Belt Weight	Steel	lbf/ft	0.094	0.101	0.114	0.168	0.228	0.047	0.054	0.060	0.087	0.128	0.161	
		kgf/m	0.140	0.150	0.170	0.250	0.340	0.070	0.080	0.090	0.130	0.190	0.240	
	Kevlar	lbf/ft	0.081	0.087	0.101	0.141	0.195	0.040	0.047	0.054	0.081	0.114	0.148	
		kgf/m	0.120	0.130	0.150	0.210	0.290	0.060	0.070	0.080	0.120	0.170	0.220	
Belt Stiffness (Open Ended)	Steel	lbf	163467	217955	326933	435911	653866	30216	47212	59452	96173	141637	194095	
		N	727139	969518	1454277	1939036	2908554	134400	210000	264444	427778	630000	863333	
	Kevlar	lbf	91048	121397	182096	242794	364192	32932	51456	64796	104817	154367	211540	
		N	405003	540004	810006	1080008	1620012	146480	228875	288213	466227	686625	940931	
Min. No. of Pulley Teeth		14					10							
Min. Pitch Diameter (Inch or mm)		2.23"					16mm							
Min. Diameter of Tensioning Idler Running on Back of Belt		inch	3.125					1.125						
		mm	80					30						
Available in FDA Compliant Construction (85 Shore A Urethane & Kevlar Cords)		Yes					No							
Standard Colors (N=Natural, W=White)		N					N, W							
Nylon Available on Tooth Side (NT)		Yes					No							
Service Temperature Range		-5° C to 70° C (23° F to 158° F)												



AT5V				ATL5V				T10VS				T10V					AT10V				
5 mm				5 mm				10 mm				10 mm					10 mm				
16 mm	25 mm	32 mm	50 mm	16 mm	25 mm	32 mm	50 mm	16 mm	25 mm	32 mm	50 mm	25 mm	32 mm	50 mm	75 mm	100 mm	150 mm	25 mm	32 mm	50 mm	75 mm
961	1602	2050	3268	1394	2369	3066	4878	944	1605	2077	3305	1605	2077	3305	5004	6704	10103	3204	4058	6621	10038
4275	7125	9120	14535	6200	10540	13640	21700	4200	7140	9240	14700	7140	9240	14700	22260	29820	44940	14250	18050	29450	44650
1126	1877	2403	3829	N/A	N/A	N/A	N/A	1091	2060	2666	4241	2060	2666	4241	6422	8603	12965	3639	4609	7520	11401
5010	8350	10688	17034	N/A	N/A	N/A	N/A	4851	9163	11858	18865	9163	11858	18865	28567	38269	57673	16185	20501	33449	50713
237	396	507	807	309	526	681	1083	252	429	555	883	429	555	883	1338	1792	2700	841	1065	1738	2635
1056	1761	2253	3591	1376	2340	3028	4818	1123	1909	2470	3929	1909	2470	3929	5950	7971	12012	3741	4739	7731	11722
52	80	98	179	68	105	136	238	131	216	298	455	114	184	328	544	788	1300	166	263	511	828
232	356	438	796	303	468	606	1060	584	959	1326	2022	505	820	1457	2422	3505	5782	738	1168	2274	3684
163	272	348	555	N/A	N/A	N/A	N/A	143	239	309	492	239	309	492	745	999	1505	393	498	813	1233
726	1210	1549	2468	N/A	N/A	N/A	N/A	638	1064	1376	2190	1064	1376	2190	3316	4442	6694	1750	2217	3617	5483
52	80	98	179	N/A	N/A	N/A	N/A	110	180	249	380	95	154	274	455	659	1086	116	184	359	581
232	356	438	796	N/A	N/A	N/A	N/A	488	802	1108	1690	422	685	1218	2024	2930	4833	518	820	1596	2585
116	220	302	510	116	220	302	510	152	289	395	669	182	289	562	942	1322	2082	278	441	858	1438
516	980	1342	2270	516	980	1342	2270	676	1284	1758	2974	811	1284	2501	4191	5881	9261	1238	1961	3818	6398
0.054	0.067	0.081	0.121	0.054	0.074	0.094	0.134	0.053	0.081	0.103	0.158	0.114	0.134	0.195	0.275	0.356	0.517	0.128	0.154	0.222	0.316
0.080	0.100	0.120	0.180	0.080	0.110	0.140	0.200	0.080	0.121	0.153	0.235	0.170	0.200	0.290	0.410	0.530	0.770	0.190	0.230	0.330	0.470
0.047	0.060	0.074	0.107	N/A	N/A	N/A	N/A	0.046	0.069	0.087	0.134	0.094	0.114	0.154	0.215	0.275	0.396	0.107	0.121	0.175	0.248
0.070	0.090	0.110	0.160	N/A	N/A	N/A	N/A	0.068	0.103	0.130	0.200	0.140	0.170	0.230	0.320	0.410	0.590	0.160	0.180	0.260	0.370
59369	98949	126655	201856	77361	131513	170194	270763	63095	107262	138810	220834	107262	138810	220834	334405	447977	675120	210253	266320	434522	658792
264075	440125	563360	897855	344118	585000	757059	1204412	280662	477125	617456	982316	477125	617456	982316	1487507	1992699	3003081	935250	1184650	1932850	2930450
40805	68008	87050	138737	N/A	N/A	N/A	N/A	35863	59771	77351	123058	59771	77351	123058	186345	249632	376206	98354	124582	203265	308176
181500	302500	387200	617100	N/A	N/A	N/A	N/A	159525	265875	344074	547390	265875	344074	547390	828904	1110419	1673449	437500	554167	904167	1370833
15				15				14				14					15				
24 mm				24 mm				45 mm				45 mm					48 mm				
2.375				2.375				3.125				3.125					4.750				
60				60				80				80					120				
No				No				No				Yes					No				
W				W				N				N					W				
No				No				No				Yes					Yes				

-5° C to 70° C (23° F to 158° F)

The specifications listed are based on Gates Mectrol's experience. However, our specifications and data do NOT cover all possible belt drive conditions. It is the responsibility of the belt drive system designer to ensure Gates Mectrol's belts are appropriate for a given system and application. The provided data is representative of our in-house experience and does not necessarily match product performance in industrial use. Gates Mectrol cannot assume any liability concerning the suitability and process ability of our products. We also cannot assume liability for process results, damages or consequential damages associated with the use of our products. Note, ultimate tensile strengths are listed for references purposes only. Ultimate tensile strength values listed above are a theoretical calculation based on average cord strength and may not represent actual tensile test results.

# Wide Belt Overview

Gates Mectrol can produce urethane timing belts in widths up to 450 mm. These belts are specifically designed for synchronous conveying applications.

Wide belts are primarily used as process conveyor belts. Process (or conversion steps) normally occur on the belt, therefore the conveyed product requires additional width.

## Features

- High strength Kevlar cord construction
- Parallel cord construction
  - No cords exposed at edges of belt
  - Better tracking
  - Uniform tensioning
- Tough polyurethane construction
  - Durable and cut resistant
  - Oil, chemical and water resistant
  - Non-marking
- Choice of polymers including FDA grades
- Nylon back and nylon tooth surface options available for quieter operation and reduced friction
- Various molded profiles and backing materials available
- No lubrication required



**Wide belts can move heavier loads, with greater precision and use smaller diameter pulleys than a comparable flat belt.**

# Wide Belt Applications

## Application Characteristics

- Replaces flat conveyor belt
  - No retensioning required
  - Lower shaft forces
  - Positive indexing
  - Higher acceleration without slippage
- High speed conveying
- Rapid indexing
- Automated process conveyor belts
- Bulk product conveying



Four 450 mm wide, timing belts accelerate skiers for faster loading of detachable chair lifts. Timing belts ensure uniform speed of each skier.

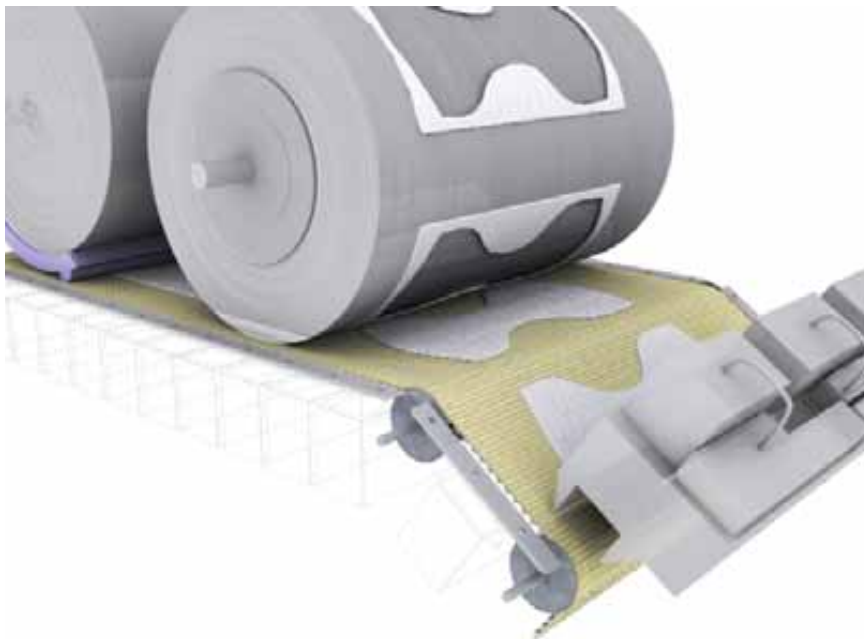

Precision high speed indexing with Gates Mectrol extra wide timing belts dramatically increases throughput and yields on diaper production lines.

>> Our Applications Engineering staff is available to you at [apps@gatesmectrol.com](mailto:apps@gatesmectrol.com) or **1-800-394-4844**



# Wide Belt Specifications

			WH	WT10
<b>Pitch (Imperial and Metric)</b>			<b>.500"</b>	<b>10 mm</b>
Ultimate Tensile Strength per Inch or 25 mm Belt Width	Kevlar	lbf/in N/25 mm	800 3557	800 3557
Max. Allowable Belt Tension per Inch or 25 mm Belt Width	Kevlar Welded	lbf/in N/25 mm	71 315	71 315
Allowable Effective Tension for the Belt Teeth (15 and More Teeth in Mesh)		lbf/in N/25 mm	330 1470	281 1250
Specific Belt Weight	Kevlar	lbf/ft/in kgf/m/cm	0.056 0.033	0.066 0.039
Specific Belt Stiffness (Open Ended)	Kevlar	lbf/in N/mm	23983 4200	23983 4200
Min. No. of Pulley Teeth			14	16
Min. Pitch Diameter (Inch or mm)			2.23"	51 mm
Min. Diameter of Tensioning Idler Running on Back of Belt		inch mm	3.12 80	3.12 80
Available in FDA Compliant Construction (85 Shore A Urethane)			Yes	Yes
Standard Color			Natural	Natural
Min. Welded Belt Length			33"	850 mm
Standard Roll Length			200 ft	60 m
Standard Slitting Lanes			N/A	N/A
Min. Width Available			6"	150 mm
Max. Width Available			18"	450 mm
Width Tolerance			± .060"	± 1.0 mm

Service Temperature Range	-5° C to 70° C (23° F to 158° F)	
Hardness	92 Shore A - Standard PU, 85 Shore A - FDA Compliant PU	
Coefficient of Friction	Urethane vs. Steel (dry)	0.5 to 0.7
	Urethane vs. Aluminum (dry)	0.5 to 0.6
	Urethane vs. UHMWPE (dry)	0.2 to 0.4
	Nylon vs. Steel (dry)	0.2 to 0.4
	Nylon vs. UHMWPE (dry)	0.1 to 0.3

The specifications listed are based on Gates Mectrol's experience. However, our specifications and data do NOT cover all possible belt drive conditions. It is the responsibility of the belt drive system designer to ensure Gates Mectrol's belts are appropriate for a given system and application. The provided data is representative of our in-house experience and does not necessarily match product performance in industrial use. Gates Mectrol cannot assume any liability concerning the suitability and process ability of our products. We also cannot assume liability for process results, damages or consequential damages associated with the use of our products. Note, ultimate tensile strengths are listed for references purposes only. Ultimate tensile strength values listed above are a theoretical calculation based on average cord strength and may not represent actual tensile test results.

# Profiled Belts Overview

Gates Mectrol timing belts can be customized with welded-on profiles to meet your application's specific holding, pushing, lifting, or actuating requirements. These profiles can be molded into almost any shape making profiled belts ideal for your assembly, packaging, inserting and other automation equipment requirements.

Our molded profiles are produced in the same tough urethane as our belting and become an integral part of the belt through thermal bonding.

## Features

- Non-marking, durable urethane construction
- Molded and located on the belt to exacting tolerances
- Can be molded to virtually any custom configuration
- Available in 85 and 92 Shore A hardness
- Available in FDA compliant polyurethane
- Thermally fused to base belt material
- Available with metal inserts, including threaded inserts

## Application Characteristics

- Pushing, carrying or actuating in packaging applications
- Product location in process applications
- Holders for mounting devices
- Interchangeable spacing for alternate product conveying

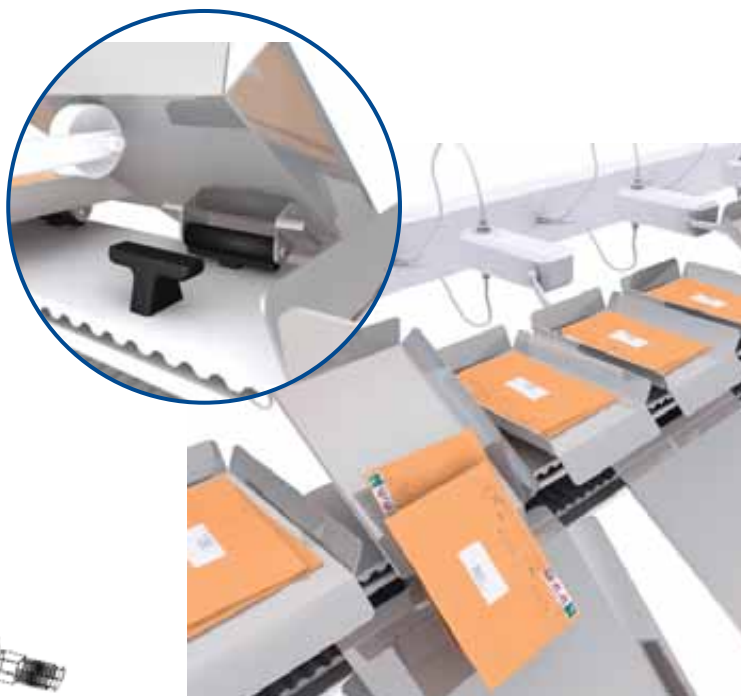

Custom profiles are used for pins and rests on a tilt-tray mail sorting machine.

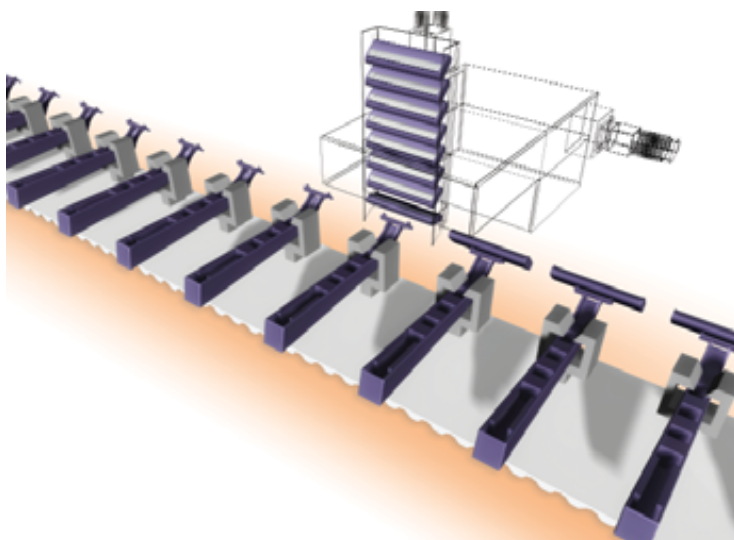

Exact placement of the profile allows for precision assembly of parts. In this application, razor heads are mounted accurately as a result of the Gates Mectrol profiled timing belt.

# Profiled Belts – Design Recommendations

Over one thousand profile designs are available from Gates Mectrol's extensive mold inventory. Visit the Gates Mectrol Profile Selector Guide at [www.gatesmectrol.com](http://www.gatesmectrol.com) to search our profile library. Our applications engineers can work with you to design any profile to meet your specific requirements. Tooling charges are minimal for most customized designs.

Although it is possible to have nearly any design utilizing welded profiles, ultimate performance for your application can be achieved by following the design guidelines outlined below:

## 1. Profile Spacing

It is recommended that the profile spacing, A, correspond with the pitch of the belt teeth. This allows for the best spacing tolerances, and minimizes the effects of the belt's overall length tolerance on the profile spacing.

Profiles can be spaced on non-pitch increments. However, if non-pitch spacing is used, the cumulative tolerance of the belt length must be considered.

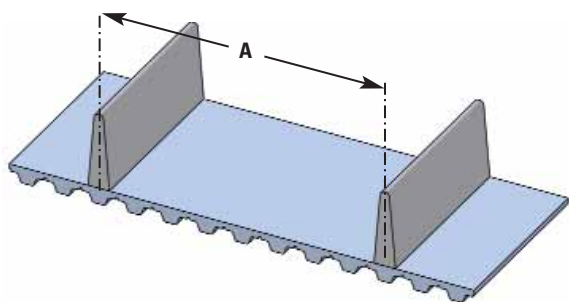

**Profile Spacing Tolerance**

Profile Spacing	Over Tooth Non-cumulative	Not Over Tooth
0.2" ≤ A < 1.0" 5 mm ≤ A < 25.4 mm	±0.015" ±0.38 mm	±0.020" ±0.5 mm
1.0" ≤ A < 9.0" 25.4 mm ≤ A < 228.6 mm	±0.020" ±0.5 mm	±0.025" ±0.6 mm
9.0" ≤ A < 18.0" 228.6 mm ≤ A < 457.2 mm	±0.025" ±0.6 mm	±0.030" ±0.8 mm
18.0" ≤ A < 27.0" 457.2 mm ≤ A < 685.8 mm	±0.030" ±0.8 mm	±0.035" ±0.9 mm
27.0" ≤ A < 36.0" 685.8 mm ≤ A < 914.4 mm	±0.035" ±0.9 mm	±0.040" ±1.0 mm

For spacing greater than 36.0", add 0.006" per ft.

For spacing greater than 914.4 mm, add 0.15 mm per 305 mm.

Tighter tolerances on profile spacing are available. Contact a Gates Mectrol Applications Engineer for more information.

## 2. Profile Dimensions

The most important considerations while dimensioning a profile are the size of the base of the profile ("foot" of the profile) and the position of the profile on the belt.

The profile thickness can affect the flexibility of the belt, and can determine the minimum allowable pulley diameter. The flexibility of the belt can be maximized, however, by positioning the profile directly over the tooth of the belt.

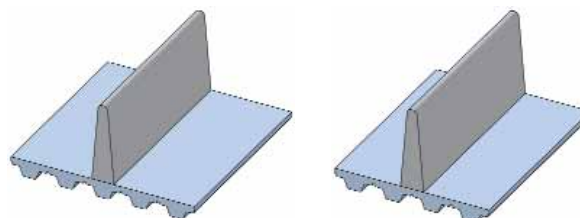

**Over Tooth**

**Not Over Tooth**

As the thickness of the foot of the profile increases, the minimum pulley diameter in the system must be increased according to the table on the next page.

The molded tolerances of the profile itself i.e. thickness, height, length, etc. are controlled within ±.010". The installed height tolerance of a profile is typically +.010", −.020".

*Gates Mectrol Applications Engineers will assist in all regards where tolerances are an issue. Please contact: [apps@gatesmectrol.com](mailto:apps@gatesmectrol.com).*

*To access all of our standard profiles visit the Profile Selector Guide at [www.gatesmectrol.com](http://www.gatesmectrol.com).*



# Profiled Belts – Design Recommendations

Minimum Number of Pulley Teeth For Profiles Over a Tooth\*

Profile "Foot" Thickness	Inch mm	1/16 1.60	1/8 3.00	3/16 5.00	1/4 6.00	5/16 8.00	3/8 10.00	7/16 11.00	1/2 13.00	5/8 16.00	3/4 19.00
XL		10	10	18	25	40	50	60	100	N/R	N/R
L		12	12	12	18	30	40	50	60	100	N/R
H, H-HF		14	14	14	14	18	25	35	45	80	100
XH		18	18	18	18	18	18	18	20	35	50
T5		12	12	18	25	40	50	60	100	N/R	N/R
AT5, ATL5		15	15	18	25	40	50	60	100	N/R	N/R
T10, T10-HF		16	16	16	16	18	25	35	45	80	100
AT10		18	18	18	18	22	25	35	45	80	100
ATL10, ATL10-HF		25	25	25	25	25	25	35	45	80	100
T20, AT20		18	18	18	18	18	18	18	20	35	50
ATL20		30	30	30	30	30	30	30	30	35	50
HTD5, STD5		14	14	16	25	40	50	60	100	N/R	N/R
HTD8, STD8		20	20	20	24	30	40	50	60	100	N/R
HTD14		28	28	28	28	28	28	30	30	50	72
HTDL14		43	43	43	43	43	43	43	43	50	72

Minimum Number of Pulley Teeth For Profiles Not Over a Tooth\*

Profile "Foot" Thickness	Inch mm	1/16 1.60	1/8 3.00	3/16 5.00	1/4 6.00	5/16 8.00	3/8 10.00	7/16 11.00	1/2 13.00	5/8 16.00	3/4 19.00
XL		12	30	45	50	60	100	N/R	N/R	N/R	N/R
L		12	20	40	45	55	60	70	80	100	N/R
H, H-HF		14	14	25	30	45	50	55	65	80	100
XH		18	18	20	30	40	45	50	54	58	60
T5		12	30	45	50	60	100	N/R	N/R	N/R	N/R
AT5, ATL5		15	30	45	50	60	100	N/R	N/R	N/R	N/R
T10, T10-HF, AT10		18	20	30	40	45	50	55	65	80	100
ATL10, ATL10-HF		25	25	30	40	45	50	55	65	80	100
T20, AT20		18	18	20	30	40	45	50	54	58	60
ATL20		30	30	30	30	40	45	50	54	58	60
HTD5, STD5		18	30	45	50	60	100	N/R	N/R	N/R	N/R
HTD8, STD8		20	20	40	45	55	60	70	80	100	N/R
HTD14		28	28	30	42	58	64	72	78	82	86
HTDL14		43	43	43	43	58	64	72	78	82	86

\*Minimum number of pulley teeth must be equal to or greater than minimum shown in the appropriate Belt Specifications Table.

N/R = not recommended

### 3. Profile Strength

The strength, and therefore capacity of the profile, depends primarily on the size of the welded profile foot.

The strength of the profile is affected by the type and direction of the force applied to it. Under high loads, the failure mode will normally be either bending and distortion of the profile and belt, or in some cases, the polyurethane may actually tear.

With a load introduced against the profile at a point 1/4" above the belt surface, the strength of the profile is 2,500 lbs. per square inch of welded foot area, or 1724 N/cm<sup>2</sup>.

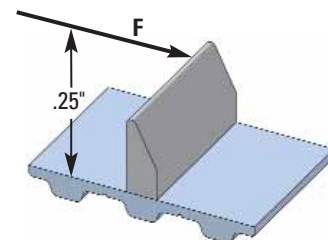



# Profiled Belts – Design Recommendations

## 4. Wide Base Profiles, and Profiles With Relief

For profiles requiring a wide base, such as pushers, one foot should be left unwelded. This allows for flexing around the pulley yet it remains rigid when loaded.

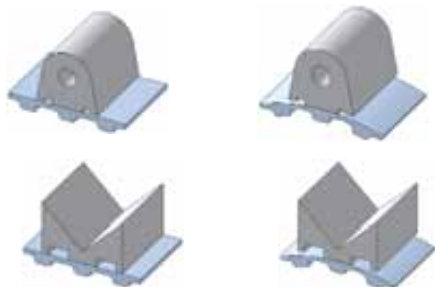

## 5. Segmented Profiles

When large profiles are required as carriers, they must be either segmented or slotted. This is necessary to allow flexing around the pulley. On the flat conveyor surface, the profiles remain intact.



## 6. Profiles With Holes

Profiles with holes for securing paddles or other attachments can be produced. Holes are either drilled before bonding, or are molded into the profile depending upon the volume and requirements of the application.

Tolerances of the hole placement depends upon whether the holes are drilled or molded. The tolerance of the hole from the belt surface is subject to the bonding process of the profile foot and the belt surface.

Generally, tolerances are as shown below. However, tighter tolerances are possible. Please consult our Applications Engineering Department.

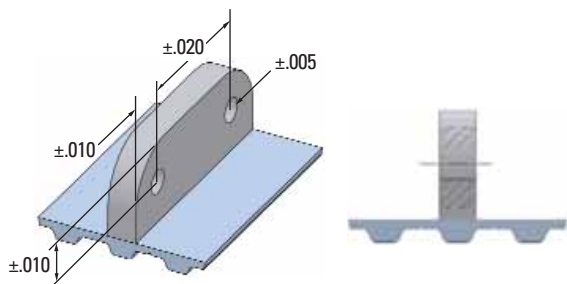

## 7. Profiles With Inserts

Profiles can be molded with metallic inserts. These are particularly useful in some applications to replace attachment chain.

The actual inserts can either be manufactured by Gates Mectrol or provided by the customer.

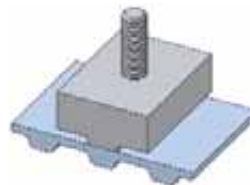

## 8. Flash Bead

During the welding process, a bead of urethane develops at the meeting point of the profile and belt.

The welding bead is removed, “de-flashed”, as necessary.

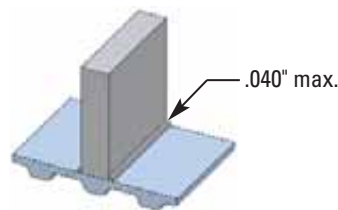

## 9. Perpendicularity

All profiles are perpendicular to 1°.

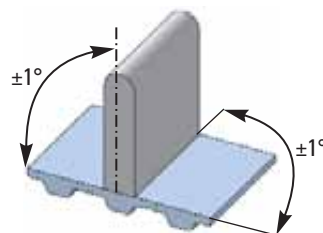

## 10. Ordering

When ordering a profiled belt, it is advisable to submit a drawing of the profiled belt.

Once a design is finalized, Gates Mectrol will submit a drawing to the customer for approval. This custom belt drawing number should then be used for future ordering.



# Profiled Belts – QuickShip Program

Gates Mectrol offers a QuickShip Program based on its most popular profiles. Under this program, orders of ten belts or less, with any of the below profiles, will ship in seven working days!

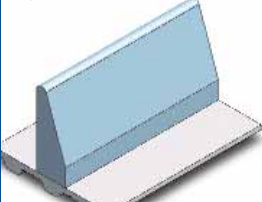
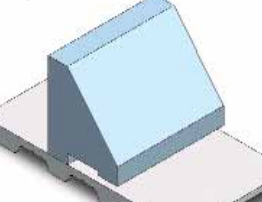
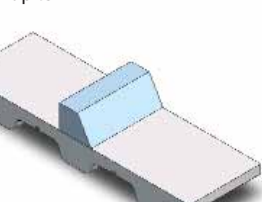
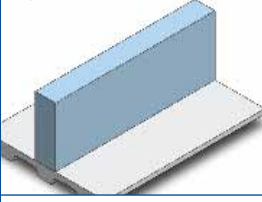
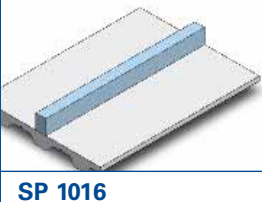
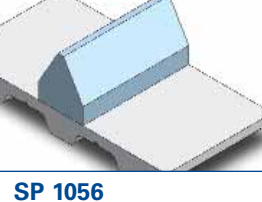
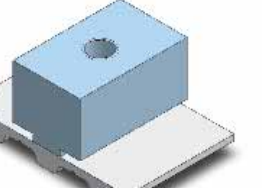
<p><b>AN 1004</b> 1.000[25.4] H x .375[9.5] W up to 12" L</p> 	<p><b>AN 1008</b> .850[21.6] H x .690[17.5] W up to 12" L</p> 	<p><b>AN 1012</b> .625[15.9] H x .250[6.4] W up to 12" L</p> 	<p><b>AN 1014</b> .157[4.0] H x .208[5.3] W up to 12" L</p> 
<p><b>AN 1018</b> .375[9.5] H x .130[3.3] W up to 12" L</p> 	<p><b>AN 1027</b> .290[7.4] H x .240[6.1] W up to 13" L</p> 	<p><b>AN 1034</b> .281[7.1] H x .591[15.0] W up to 12" L</p> 	<p><b>RC 1001</b> .500[12.7] H x .250[6.4] W up to 12" L</p> 
<p><b>RC 1004</b> .750[19.1] H x .250[6.4] W up to 12" L</p> 	<p><b>RC 1007</b> .250[6.4] H x .250[6.4] W up to 12" L</p> 	<p><b>RC 1009</b> 1.000[25.4] H x .250[6.4] W up to 12" L</p> 	<p><b>RC 1042</b> .125[3.2] H x .250[6.4] W up to 12" L</p> 
<p><b>RC 1043</b> .188[4.8] H x .125[3.2] W up to 12" L</p> 	<p><b>RT 1007</b> .500[12.7] H x .125[3.2] W up to 12" L</p> 	<p><b>SP 1011</b> .353[9.0] H x .314[8.0] W up to 12" L</p> 	<p><b>SP 1013</b> .728[18.5] H x .788[20.0] W up to 2.5" L</p> 
<p><b>SP 1016</b> .492[12.50] H x .472[12.0] W up to 6.5" L</p> 	<p><b>SP 1051</b> .787[20] H x .236[6] W up to 1.969" L</p> 	<p><b>SP 1056</b> .563[14.3] H x .626[15.90] W up to 1" L</p> 	<p><b>SP 1089</b> .394[10.0] H x .591[15.01] W up to 1.969" L</p> 

>> For more information about the QuickShip Program visit [www.gatesmectrol.com](http://www.gatesmectrol.com) or call **1-800-394-4844**

# Backings

Most belt types can be modified by adding a backing to achieve a desired coefficient of friction, abrasion resistance or cushion. A backing can also be added and then milled to create pockets for product transfer. Gates Mectrol offers over 20 backings to meet your needs.

## Application Characteristics

- High friction for feeding or separating applications
- Low friction for light feed or accumulation requirements
- Ability to conform to unusual product shapes
- Combine friction with vacuum for ultimate grab

## Features

A customized backing can provide:

- A dramatic increase or decrease in the coefficient of friction
- Varying levels of cushioning and durability through material thickness and hardness selection
- Static conductivity
- Various levels of chemical resistance
- An ability to alter wear characteristics



**Its combined characteristics of high friction and abrasion resistance make the seamless Thermoplastic Rubber backing ideal for box folding applications.**

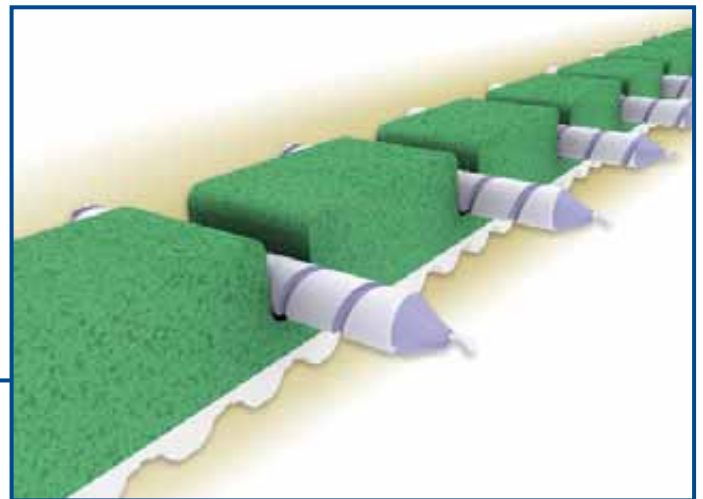

**A unique foam backing is used to carefully grasp and transport candles for cooling.**



# Backings

## Perform a wide variety of functions

Many applications require belts with specific surface characteristics. A wide variety of co-extruded as well as post-laminated backings are available to solve your toughest application requirements. Specifications follow.

- Special nylon fabric can be added to the belt back or tooth side during the manufacturing process. This reduces the coefficient of friction for sliding surfaces or product accumulation
- High friction surfaces
- A variety of materials can be added for vibration dampening
- An antistatic surface is available with a resistivity of less than  $10^6$  Ohms/Square

## Polyurethane

Gates Mectrol urethane backings are available in several different varieties. Available in different durometers, with different coefficients of friction, urethane backings are the toughest and most durable backing material.

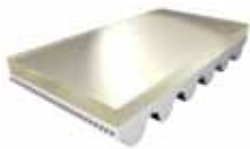

Clear Urethane



Glass Backing



Ridge Top



White Urethane

## Rubber

Feeding applications generally require extremely high friction. Rubber can provide this high friction, even while wet. Some rubber backings also offer antistatic properties, higher temperature ratings, and good chemical and abrasion resistance.



Linatex®



Linaplus FG™



Linatrile®



Tan Natural Rubber



Thermoplastic Rubber

# Backings

## Foam

Many applications require a combination of friction and the ability to conform to unusual product shapes. Gates Mectrol foam backings are available in different densities for various compliance, cushioning and friction surfaces. Belts can be constructed with a foam layer for cushioning and a tougher high friction outer layer.

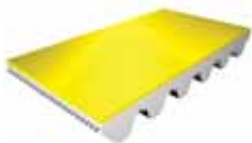

HD Yellow



Yellow



Blue



Green



Brown



Red



Neoprene



Natural

## PVC

Available with unusual surface patterns and characteristics, PVC backings offer a well bonded, economical solution with very good wear properties.



Rough Top



Small Pebble



Large Pebble



Herringbone



Blue PVC



White PVC

## Specialty Backings



Antistatic Coating

# Backings – Specifications

## Polyurethane

92A Urethane	<b>U1*</b>	Same as standard 92 A hardness base material. Very tough and durable.
85A Urethane	<b>U2*</b>	Softer PU than base material. Higher friction, more flexibility, similar durability.
HV1 Urethane	<b>U41</b>	Specifically compounded for very high coefficient of friction.
75A Urethane	<b>U3*</b>	Softer version of standard urethane. Better friction, more compression, greater flexibility, very tough.
Glass Backing	<b>G32</b>	Longitudinal groove pattern for glass conveying. Good friction and gaps for holding back abrasives and dirt.
Ridge Top	<b>G21</b>	Durable backing with longitudinal ridges. Ideal for conveying oily steel.
75A Urethane	<b>U5*</b>	Softer, high friction with very good abrasion resistance.

## Rubber

Linatex	<b>L**</b>	High friction, pure gum rubber. Good abrasion resistance, excellent for pulling and feeding applications.
Linaplus FG	<b>LP**</b>	FDA approved, high friction pure gum rubber.
Linatrilite	<b>LR*</b>	Nitrile rubber combines good abrasion resistance with oil resistance and high service temperature (230° F/100° C).
Tan Natural Rubber	<b>LT**</b>	Natural pure gum rubber, high friction.
Thermoplastic Rubber	<b>RM*</b>	High friction, ideal for conveying applications. Good oil, ozone and abrasion resistance.

## Foam

High Density PU Yellow Foam	<b>FUY*</b>	High friction. Very good abrasion resistance, excellent for paper feed applications.
Yellow PU Foam	<b>FY*</b>	Lower density. Excellent cushioning and conforming to products while providing good friction.
Blue PU Foam	<b>FB*</b>	Low density. Excellent cushioning and conforming to products while providing good friction.
Green PU Foam	<b>FG*</b>	Mid range density, firmer holding and cushioning, excellent friction.
Brown PU Foam	<b>FN*</b>	Mid range density, firmer holding and cushioning, excellent friction.
Red PU Foam	<b>FR*</b>	Upper range density, firm holding and cushioning, good friction and abrasion resistance.
Neoprene Foam	<b>LF**</b>	Black neoprene good abrasion resistance and compliance.
Natural PU Foam	<b>FC*</b>	Mid range density. Less demanding applications.

## PVC

Rough Top	<b>RT</b>	Intricate surface modeling, excellent friction surfaces. Great for glass and incline conveyors.
Small Pebble Top	<b>SPT</b>	Textured surface with small nubs for non-slip surface.
Large Pebble Top	<b>LPT</b>	Textured surface with larger nubs for non-slip surface.
Herringbone	<b>PH</b>	Raised herringbone pattern for non-slip and dispersing surface.
Blue PVC	<b>PB</b>	Smooth high sheen, high friction surface.
White PVC	<b>PW</b>	Smooth white, FDA high friction surface for non-abrasive applications.

## Special

Antistatic Coating	<b>ATB</b>	Extremely good conductivity characteristics for electronic conveying applications.
--------------------	------------	------------------------------------------------------------------------------------

Maximum width available for all backings is 6".



# Backings – Specifications

	Hardness Shore A / Density Kg/m <sup>3</sup>	Material Thickness mm	Abrasion Resistance Rating ‡	Static Coefficient of Friction †	Kinetic Coefficient of Friction †	Max. Temp. Degrees C	Pulley Diameter Factor	Oil Resistance	Color
<b>Polyurethane</b>									
<b>U1*</b>	92	2 or 3	10	0.5	0.5	80	30	E	Clear
<b>U2*</b>	85	2 or 3	9	0.6	0.5	80	30	E	Clear
<b>U41</b>	80	1	8.5	1.0	0.8	80	30	E	Clear
<b>U3*</b>	75	2 or 3	8	0.6	0.6	70	30	E	Clear
<b>G32</b>	75	5	8	0.6	0.6	70	Ø100mm	E	Clear
<b>G21</b>	85	3	9	0.6	0.5	80	Ø100mm	E	Clear
<b>U5*</b>	75	2 or 3	8	0.6	0.6	70	25	E	White

## Rubber

<b>L**</b>	35	1/16" to 1/2"	6	1.6	1.6	60	20	P	Red
<b>LP**</b>	38	1/16" to 3/16"	6	1.4	1.4	60	20	P	White
<b>LR*</b>	55	3 to 5	6.5	1.1	1.0	110	25	E	Orange
<b>LT**</b>	40	1/16" to 1/4"	6	1.5	1.5	60	20	P	Tan
<b>RM*</b>	57	2, 3, 6	7	2.1	1.4	105	25	G	Red

## Foam

<b>FUY*</b>	50	2 to 5	5.5	0.8	0.8	60	30	E	Yellow
<b>FY*</b>	- / 160	6 to 12	3	1.0	1.0	60	15	E	Yellow
<b>FB*</b>	- / 220	6 to 12	3.5	0.8	0.8	60	15	E	Blue
<b>FG*</b>	20 / 300	6 to 12	4	1.0	1.0	60	15	E	Green
<b>FN*</b>	30 / 400	6 to 12	4	0.8	0.8	60	15	E	Brown
<b>FR*</b>	40 / 500	6 to 12	4.5	0.9	0.9	60	20	E	Red
<b>LF**</b>	- / 250	1/8" to 1/2"	3	0.9	0.9	60	15	P	Black
<b>FC*</b>	30 / 400	2 to 5	4	0.6	0.5	60	15	E	Natural

## PVC

<b>RT</b>	40	4.5	5.5	1.4	1.3	60	Ø 90mm	P	Blue-green
<b>SPT</b>	50	1.5	5.5	0.7	0.6	60	Ø 25mm	P	White
<b>LPT</b>	35	6	5.5	0.8	0.7	60	Ø 40mm	P	White
<b>PH</b>	40	4.5	5.5	0.6	0.3	60	Ø 90mm	P	White
<b>PB</b>	40	1 or 2	5	1.1	1.1	60	Ø 40mm	P	Blue-green
<b>PW</b>	75	2	5	1.1	1.1	60	Ø 40mm	P	White

## Special

<b>ATB</b>	92	N/A	7.5	0.3	0.3	80	N/A	E	Black
------------	----	-----	-----	-----	-----	----	-----	---	-------

\* Add thickness in mm to designator

\*\* Add thickness in 1/16" to designator

‡ 10 = very high resistance

† Friction measured against aluminum

Oil resistance: E = Excellent G = Good P = Poor

Minimum Pulley Diameter = (Pulley Diameter Factor) x (Material Thickness)  
or above listed diameter

Note: Pulley diameter must be greater than or equal to the minimum pulley  
required for a given belt type. See belt specifications.

# Fabrication Capabilities

Gates Mectrol offers a wide range of belt modifications and a full range of secondary fabrication possibilities.

Whether grinding edges and surfaces to tight tolerances, punching and machining holes and slots, or CNC machining of three dimensional contours, Gates Mectrol can provide a complete solution.

## Features

- Nearly unlimited customizing options
- Ground tolerances on nearly any dimension for extra precision
- Unusual shapes, contours and configurations
- Holes, slots, and any CNC machined shape in the belt surface
- Combination of primary tooling and secondary machining to achieve any design potential

## Application Characteristics

- Vacuum conveying belts
  - Machined tooth side and perforations
- Precision machined belts for precise movement of product
- Distinct product orientation and location for automated process steps

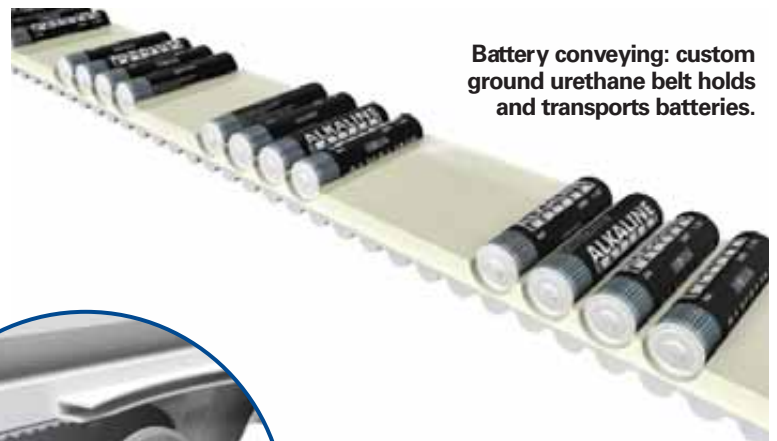

**Battery conveying: custom ground urethane belt holds and transports batteries.**

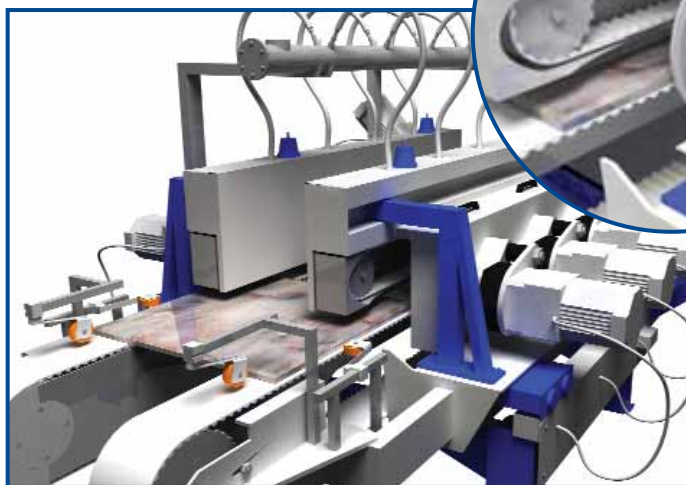

**Tile squaring machine utilizes custom belts with precision ground thickness and width.**

>> Our Applications Engineering staff is available to you at [apps@gatesmectrol.com](mailto:apps@gatesmectrol.com) or **1-800-394-4844**



# Truly Endless Belt Overview

Certain power transmission and high performance positioning applications require more strength and stiffness than a welded belt can provide. Gates Mectrol offers two types of truly endless belts to meet these needs.

- **Synchro-Power®** belts are cast on fixed molds and have a continuously wound steel cord. They are available in stock sizes.
- **Flex** belts are extruded to custom lengths ranging from 1.5 to 23.5 meters. A unique process provides the flexibility to have custom sized belts without expensive tooling.

## Application Characteristics

- Power transmission
- High power, high performance conveying
- Harsh environments
  - Abrasion and chemical resistance
- Applications where cleanliness is critical

## Features

- Helically wound cords for high strength, truly endless power transmission capabilities
- High quality, thermoset polyurethane designed specifically for timing belt applications (Synchro-Power) or thermoplastic urethane for longer length belts (Flex)
- Standard molded sleeves (Synchro-Power) or custom length belts available - up to 23.5 meters (Flex)
- Nylon tooth surface option available on Flex belts for quieter operation

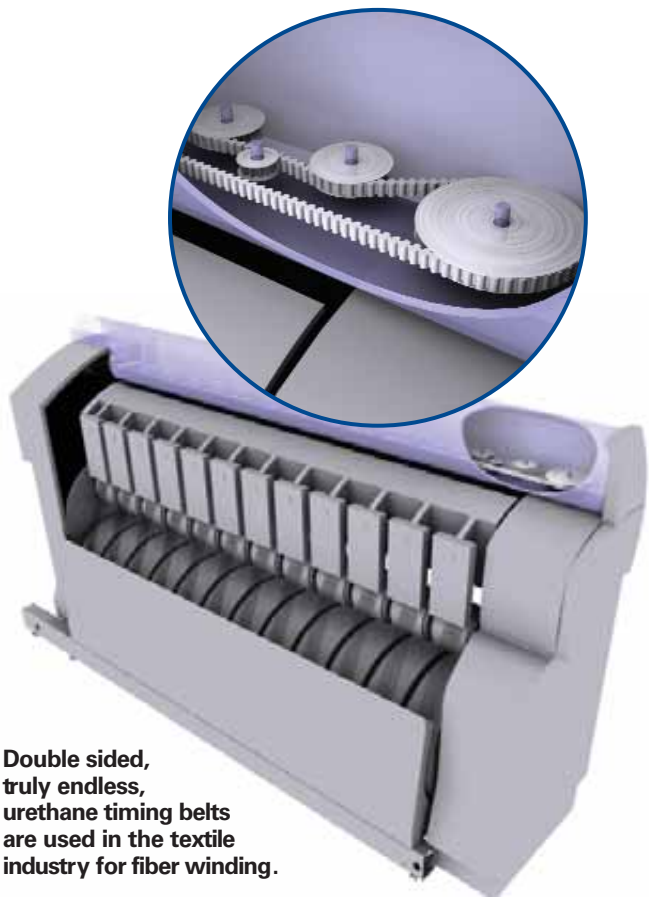

**Double sided, truly endless, urethane timing belts are used in the textile industry for fiber winding.**

>> Our Applications Engineering staff is available to you at [apps@gatesmectrol.com](mailto:apps@gatesmectrol.com) or **1-800-394-4844**

# Synchro-Power (Cast) Belts

Synchro-Power belts, **cast belts**, are produced on dedicated tooling and are available from stock in the sizes listed. For belt lengths not listed, please consult a Gates Mectrol applications engineer.



## Available Widths

Pitch	Min.	Max.	Max. Width Exceptions
XL	.250"	11.81"	
L	.375"	11.81"	
H	.375"	11.81"	
T2.5	4 mm	300 mm	240 mm max width for belt lengths 120 mm, 145 mm
T5	6 mm	300 mm	240 mm max width for belt lengths 150 mm, 165 mm
DT5	6 mm	300 mm	
T10	10 mm	300 mm	
DT10	10 mm	300 mm	
AT5	6 mm	300 mm	
AT10	16 mm	300 mm	

## Belt Length, inches

No. of Teeth	XL	L	H
Pitch	.200"	.375"	.500"
40		15	
48			24
50		18.75	
54		20.25	27
55	11		
56		21	
60	12	22.5	30
64		24	
65	13		
66			33
67	13.4		
68		25.5	
70	14		
72		27	36
75	15		
76		28.5	
78			39
80	16	30	
84			42
85	17		
86		32.25	
90	18		45
92		34.5	
95	19		
96			48
97	19.4		
98		36.75	
100	20		
102			51
104		39	
105	21		
110	22		
112		42	
115	23		
120	24	45	
125	25		
130	26		

Truly Endless Belts

# Synchro-Power (Cast) Belts

Truly Endless Belts

No. of Teeth	Belt Length (mm)		
	T2.5	T5	DT5
30		150	
33		165	
36		180	
37		185	
40		200	
43		215	
44		220	
45		225	
48	120		
49		245	
50		250	
51		255	
52		260	
54		270	
55		275	
56		280	
59	145	295	
61		305	
64	160		
66		330	
68		340	
70		350	
71	177.5	355	
72	180		
73	182.5	365	
78		390	
80	200	400	
82		410	410
84		420	

No. of Teeth	Belt Length (mm)		
	T2.5	T5	DT5
89		445	
90		450	
91		455	
92	230		460
95		475	
96		480	
98	245		
100		500	
102		510	
103			515
105		525	
106	265		
109		545	
110		550	
112		560	
114	285		
115		575	
116	290		
118		590	590
120		600	
122	305	610	
124		620	620
126		630	
127	317.5		
128		640	
130		650	
132	330	660	
135		675	
138		690	

No. of Teeth	Belt Length (mm)		
	T2.5	T5	DT5
140		700	
144		720	
145		725	
150		750	750
152	380		
156		780	
160		800	
163		815	815
168	420	840	
170		850	
172			860
180		900	
188		940	940
192	480		
198		990	
200	500		
215		1075	
216	540		
220		1100	
240	600		
243		1215	
248	620		
260	650		
263		1315	
276		1380	
280	700		
312	780		
366	915		
380	950		

## To Order Synchro-Power Belts

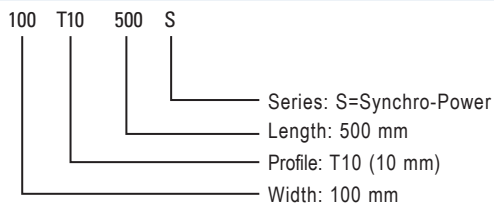

# Synchro-Power (Cast) Belts

No. of Teeth	Belt Length (mm)	
	T10	DT10
26	260	260
37	370	
40	400	
41	410	
44	440	
45	450	
50	500	
53	530	530
56	560	
60	600	
61	610	
63	630	630
66	660	660
69	690	
70	700	
72	720	720
73	730	
75	750	
78	780	
80	800	
81	810	
84	840	840
85	850	
88	880	
89	890	
90	900	
91	910	
92	920	920
95	950	
96	960	
97	970	

No. of Teeth	Belt Length (mm)	
	T10	DT10
98	980	980
100	1000	
101	1010	
108	1080	
110	1100	
111	1110	
114	1140	
115	1150	
121	1210	1210
124	1240	1240
125	1250	1250
130	1300	
132	1320	1320
135	1350	1350
139	1390	
140	1400	
142	1420	1420
144	1440	
145	1450	
146	1460	
150	1500	
156	1560	
160	1600	
161	1610	1610
170	1700	
175	1750	
178	1780	
188	1880	1880
196	1960	
225	2250	

No. of Teeth	Belt Length (mm)	
	AT5	AT10
45	225	
50		500
51	255	
55	275	
56	280	560
60	300	
61		610
66		660
68	340	
70		700
73		730
75	375	
78	390	780
80		800
81		810
84	420	840
89		890
91	455	
92		920
96		960
98		980
100	500	
101		1010
105		1050
108		1080
109	545	
115		1150
120	600	1200
121		1210
122	610	
125		1250
126	630	
132	660	1320
140		1400
144	720	
150	750	1500
156	780	
160		1600
165	825	
170		1700
180		1800
195	975	
210	1050	
225	1125	
300	1500	

Truly Endless Belts

# Synchro-Power (Cast) Belts

Synchro-Power belts are available with steel reinforcing cords.

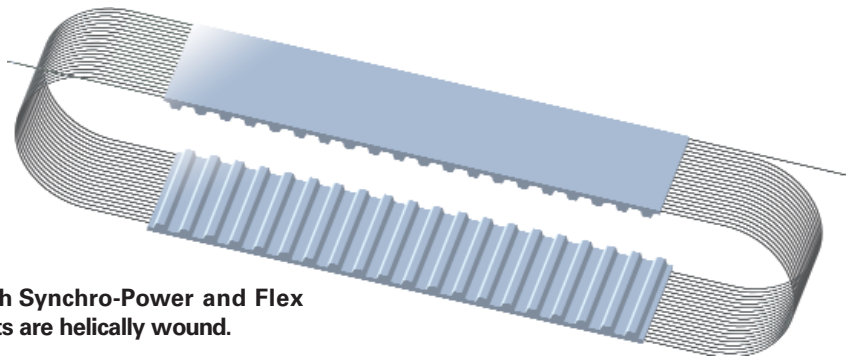

Both Synchro-Power and Flex belts are helically wound.

## Synchro-Power Specifications

		XL	L	H	T2.5	T5	T5 DL	AT5	T10	T10 DL	AT10
<b>Pitch</b>		<b>.200"</b>	<b>.375"</b>	<b>.500"</b>	<b>2.5mm</b>	<b>5mm</b>	<b>5mm</b>	<b>5mm</b>	<b>10mm</b>	<b>10mm</b>	<b>10mm</b>
Ultimate Tensile Strength per Inch or 25mm Belt Width	lbf/in	920	1925	2203	600	920	920	1884	2157	2157	3216
	N/25mm	4092	8562	9798	2670	4092	4092	8380	9594	9594	14305
Max. Allowable Belt Tension per Inch or 25mm Belt Width	lbf/in	232	473	697	91	232	232	448	558	558	1017
	N/25mm	1032	2104	3101	404	1032	1032	1992	2482	2482	4523
Allowable Effective Tension for the Belt Teeth (15 and More Teeth in Mesh)	lbf/in	180	360	441	61	200	200	290	380	380	580
	N/25mm	800	1600	1960	270	890	890	1290	1690	1690	2580
Specific Belt Weight	lbf/ft/in	0.036	0.059	0.071	0.024	0.035	0.044	0.058	0.075	0.101	0.111
	kgf/m/cm	0.021	0.035	0.042	0.014	0.0206	0.026	0.034	0.044	0.059	0.065
Specific Belt Stiffness	lbf/in	58004	118263	174338	23075	58932	58932	113782	141761	141761	258298
	N/mm	10157	20709	30529	4040	10320	10320	19925	24825	24825	45233
Min. No. of Pulley Teeth		10	10	14	12	10	10	15	14	14	15
Min. Pitch Diameter	mm	.64"	1.19"	2.23"	10	16	16	24	45	45	48
Min. Diameter of Tensioning Idler Running on Back of Belt	in	1.125	2.375	3.125	0.787	1.125	0.625	2.375	3.125	1.875	4.75
	mm	30	60	80	20	30	16	60	80	45	120
Service Temperature Range		-5 ° C to 70 ° C (23 ° F to 158 ° F)									
Hardness		88 Shore A									
Standard Color		Natural									

### Width Tolerances

Slit Belts	mm	±.02"	±.03"	±.03"	±0.3	±0.5	±0.5	±0.5	±0.5	±0.5	±0.75
------------	----	-------	-------	-------	------	------	------	------	------	------	-------

The specifications listed are based on Gates Mectrol's experience. However, our specifications and data do NOT cover all possible belt drive conditions. It is the responsibility of the belt drive system designer to ensure Gates Mectrol's belts are appropriate for a given system and application. The provided data is representative of our in-house experience and does not necessarily match product performance in industrial use. Gates Mectrol cannot assume any liability concerning the suitability and process ability of our products. We also cannot assume liability for process results, damages or consequential damages associated with the use of our products. Note, ultimate tensile strengths are listed for references purposes only. Ultimate tensile strength values are a theoretical calculation based on average cord strength and may not represent actual tensile test results.



# Flex Belts

Flex belts are produced with steel reinforcing cords and the same tough urethane as Gates Mectrol's standard linear belts.

	XL	L	H	XH	T5	AT5	T10	AT10	ATL10	T20	AT20	ATL20	HTD5	HTD8	HTD14
Minimum Length without NT*	59.20"	59.25"	59.50"	59.50"	1.50 m	1.50 m	1.50 m	1.50 m	1.50 m	1.50 m	1.50 m	1.50 m	1.55 m	1.50 m	1.55 m
Minimum Length with NT*	75.00"	75.00"	75.00"	75.25"	1.90 m	1.90 m	1.90 m	1.90 m	1.90 m	1.90 m	1.90 m	1.90 m	N/A	1.90 m	N/A
Maximum Length	779.60"	779.63"	780.00"	779.63"	19.80 m	19.80 m	19.80 m	19.80 m	19.80 m	19.80 m	19.80 m	19.80 m	14.90 m	19.80 m	23.49 m
Minimum Width	.25"	.25"	.50"	1.0"	10 mm	10 mm	16 mm	25 mm	25 mm	32 mm	32 mm	32 mm	25 mm	25 mm	25 mm
Maximum Width	6.0"	6.0"	6.0"	6.0"	150 mm	150 mm	150 mm	150 mm	150 mm	150 mm	150 mm	150 mm	100 mm	150 mm	100 mm

\* NT = nylon on tooth side

## Flex Width Tolerances

Up to 2" Up to 50 mm	±0.020"	±0.020"	±0.020"	±0.040"	±0.5 mm	±0.5 mm	±0.5 mm	±0.75 mm	±1.0 mm	±1.0 mm	±1.0 mm	±1.5 mm	±0.5 mm	±0.75 mm	±1.0 mm
>2" - 6" >50 - 150 mm	±0.030"	±0.030"	±0.030"	±0.040"	±0.75 mm	±0.75 mm	±0.75 mm	±1.0 mm	±1.5 mm	±1.0 mm	±1.5 mm	±1.5 mm	±0.75 mm	±1.0 mm	±1.5 mm

## Flex Specifications

	XL	L	H	XH	T5	AT5	T10	AT10	ATL10	T20	AT20	ATL20	HTD5	HTD8	HTD14	
<b>Pitch (Imperial and Metric)</b>	<b>.200"</b>	<b>.375"</b>	<b>.500"</b>	<b>.875"</b>	<b>5 mm</b>	<b>5 mm</b>	<b>10 mm</b>	<b>10 mm</b>	<b>10 mm</b>	<b>20 mm</b>	<b>20 mm</b>	<b>20 mm</b>	<b>5 mm</b>	<b>8 mm</b>	<b>14 mm</b>	
Ultimate Tensile Strength per Inch or 25 mm Belt Width	lbf/in N/25 mm	759 3375	1474 6555	1605 7140	3204 14250	759 3375	1602 7125	1605 7140	3204 14250	5445 24220	3170 14102	5445 24220	7306 32500	1602 7125	3204 14250	4667 20760
Max. Allowable Belt Tension per Inch or 25 mm Belt Width	lbf/in N/25 mm	192 853	371 1652	429 1909	854 3801	189 840	396 1761	429 1909	841 3741	1317 5860	832 3702	1317 5860	1599 7114	396 1761	841 3741	1159 5156
Allowable Effective Tension for Belt Teeth (15 and More Teeth in Mesh)	lbf/in N/25 mm	180 800	360 1600	441 1960	879 3910	200 890	290 1290	380 1690	580 2580	580 2580	710 3160	1221 5430	1221 5430	229 1020	420 1870	771 3430
Specific Weight	lbf/ft/in kgf/m/cm	0.036 0.021	0.059 0.035	0.066 0.039	0.180 0.105	0.037 0.022	0.055 0.032	0.074 0.043	0.096 0.056	0.114 0.067	0.125 0.073	0.169 0.099	0.185 0.108	0.070 0.041	0.101 0.059	0.182 0.107
Belt Specific Stiffness	lbf/in N/mm	47950 8400	92800 16255	109000 19085	213600 37410	47950 8400	100500 17605	109000 19085	213600 37410	334600 58600	213600 37410	334600 58600	440000 77050	100532 17605	213600 37410	294400 51560
Min. No. of Pulley Teeth		10	10	14	18	10	15	14	15	25	15	18	30	14	20	28
Min. Pitch Diameter (Inch or mm)		.64"	1.19"	2.23"	5.01"	16 mm	24 mm	45 mm	48 mm	80 mm	96 mm	115 mm	191 mm	22 mm	51 mm	125 mm
Min. Diameter of Tensioning Idler Running on Back of Belt	in mm	1.125 30	2.375 60	3.125 80	5.875 150	1.125 30	2.375 60	3.125 80	4.750 120	5.875 150	4.750 120	7.125 180	9.875 250	2.375 60	4.750 120	7.875 200
Service Temperature Range		-5° C to 70° C (23° F to 158° F)														
Hardness		92 Shore A														
Standard Color		White														

### To Order Flex Belts (Imperial Pitch)

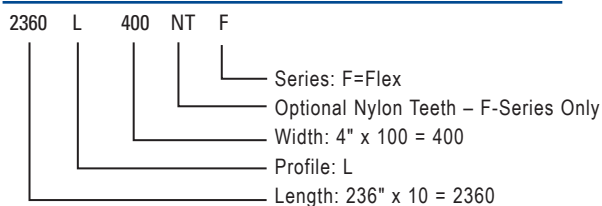

### To Order Flex or Synchro-Power Belts (Metric Pitch)

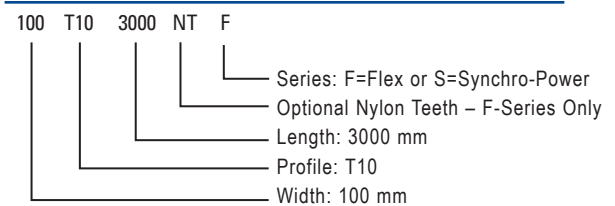

# Flat Belt Overview

Gates Mectrol offers a full line of high strength, low stretch flat belts for lifting and positioning applications. These flat belts are typically sold in open ended lengths and are clamped at each end.

## Application Characteristics

- Heavy load lifting or lowering
- Allows for “slip” requirement
- Smooth uniform motion
- Small bending radius for small design envelope
- Very low stretch characteristics

## Features

- Smooth, vibration free operation
- Use with small pulley diameters
- High strength, low stretch for long life
- Sealed edges, no cord fraying
- Easily guided with flanged pulleys
- Kevlar or steel cord construction
- No lubrication needed
- No retensioning required

Gates Mectrol's Kevlar reinforced urethane flat belts have limited stretch, are oil and cut resistant, making them ideal for harsh environments such as metal stamping conveyors.

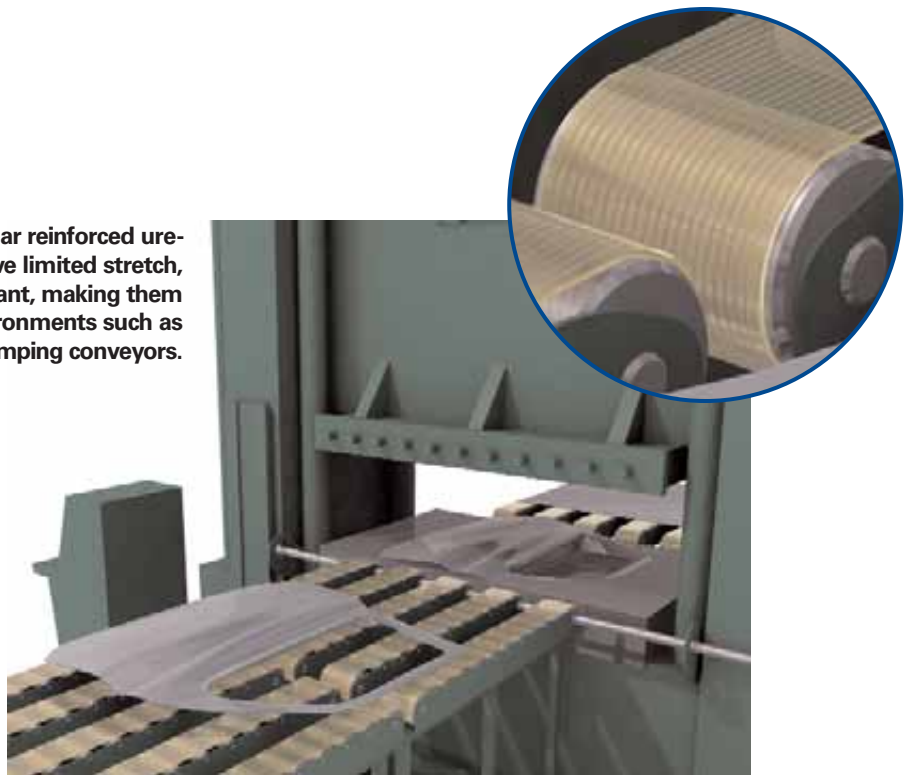

>> Our Applications Engineering staff is available to you at [apps@gatesmectrol.com](mailto:apps@gatesmectrol.com) or **1-800-394-4844**

# Flat Belts

		F8	FL8	F12	FL12	FX9, FX12
Min. Welded Belt Length	inch	19	21	20	24	N/A
	mm	483	533	508	610	N/A
Standard Roll Length	feet	200	200	200	200	200
	meters	61	61	61	61	61
Standard Slitting Lanes	inch	1	1	1	1	1
	mm	25	25	25	25	25

All roll lengths are +/- 1%

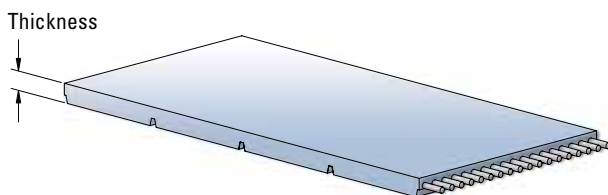

## Nominal Thickness

F8	0.080"
FL8	0.080"
F12	0.125"
FL12	0.125"
FX9	0.090"
FX12	0.120"

## Available Widths

Inch	mm	F8, FL8, F12, FL12	FX9	FX12
1/2	12.7	X		
5/8	15.875			X
3/4	19.1	X		X
15/16	23.8125		X	X
1	25.4	X		X
1 1/4	31.75			X
1 1/2	38.1	X		
2	50.8	X		
3	76.2	X		
4	101.6	X		

All belts are available in any width between the minimum and maximum listed width.

## Width Tolerances

Width	F8, FL8, F12, FL12	FX9, FX12
Up to 2"	+/- .020"	+/- .030"
>2" - 4"	+/- .030"	N/A

# Flat Belt Specifications

			F8	FL8	F12	FL12	FX9	FX12
<b>Nominal Thickness</b>	<b>inch</b>		<b>.080</b>	<b>.080</b>	<b>.125</b>	<b>.125</b>	<b>.090</b>	<b>.120</b>
	<b>mm</b>		<b>2.0</b>	<b>2.0</b>	<b>3.0</b>	<b>3.0</b>	<b>2.3</b>	<b>3.0</b>
Ultimate Tensile Strength per Inch or 25 mm Belt Width	Steel	lbf/in N/25 mm	1605 7140	3204 14250	1605 7140	5445 24220	N/A N/A	N/A N/A
	Kevlar	lbf/in N/25 mm	1818 8085	N/A N/A	1818 8085	N/A N/A	4090 18190	4680 20820
Max. Allowable Belt Tension per Inch or 25 mm Belt Width	Steel	Open Ended	lbf/in N/25 mm	436 1939	854 3800	436 1939	1338 5953	N/A N/A
		Welded	lbf/in N/25 mm	218 969	N/A N/A	218 969	N/A N/A	N/A N/A
Max. Allowable Belt Tension per Inch or 25 mm Belt Width	Kevlar	Open Ended	lbf/in N/25 mm	243 1080	N/A N/A	243 1080	N/A N/A	1020 4540
		Welded	lbf/in N/25 mm	121 540	N/A N/A	121 540	N/A N/A	N/A N/A
Specific Belt Weight	Steel	lbf/ft/in	.057	.073	.078	.113	N/A	N/A
		kgf/m/cm	.033	.043	.046	.066	N/A	N/A
Specific Belt Weight	Kevlar	lbf/ft/in	.045	N/A	.066	N/A	.043	.060
		kgf/m/cm	.026	N/A	.039	N/A	.025	.035
Specific Belt Stiffness (Open Ended)	Steel	lbf/in	109000	213600	109000	334600	N/A	N/A
		N/mm	19085	37410	19085	58600	N/A	N/A
Specific Belt Stiffness (Open Ended)	Kevlar	lbf/in	60700	N/A	60700	N/A	90000	130000
		N/mm	10635	N/A	10635	N/A	15760	22760
Min. Pulley Diameter	in	2.0	2.375	2.0	3.0	3.0	4.0	
	mm	50	60	50	75	75	100	
Min. Diameter of Tensioning Idler Running on Back of Belt	in	3.0	4.75	3.0	6.00	4.5	6.0	
	mm	80	120	80	150	115	150	
Standard Material			PU	PU	PU	PU	PU or TPR	PU or TPR
Standard Colors (N=Natural, BK=Black)			N	BK	N	BK	BK	BK

Do not use Gates Mectrol belts, pulleys or sprockets in applications that depend solely upon the belt to raise/lower, support or sustain a mass without an independent safety backup system. The specifications listed are based on Gates Mectrol's experience. However, our specifications and data do NOT cover all possible belt drive conditions. It is the responsibility of the belt drive system designer to ensure Gates Mectrol's belts are appropriate for a given system and application. The provided data is representative of our in-house experience and does not necessarily match product performance in industrial use. Gates Mectrol cannot assume any liability concerning the suitability and process ability of our products. We also cannot assume liability for process results, damages or consequential damages associated with the use of our products. Note, ultimate tensile strengths are listed for references purposes only. Ultimate tensile strength values listed above are a theoretical calculation based on average cord strength and may not represent actual tensile test results.

## To Order Flat Belts

600 F12 200 ( ) ( )

Insert "NB" for Nylon Back,  
 "NT" for Nylon Tooth (flight side), "NTB" for Nylon on Both Sides.  
 "FDA" for FDA  
 Insert "K" if specifying Kevlar  
 Width: 2.0" x 100 = 200  
 Belt Type: F12  
 Length: 60.0" x 10 = 600

# Flat Belt – Design Recommendations

- In contrast to fabric coated flat belts, Gates Mectrol flat belts have very high strength and extremely low stretch. They are designed to be run on flat faced pulleys with flanges. Crowned pulleys should not be used.

If crowned pulleys are used, the maximum allowable crown is 1.5% of belt width.

- Gates Mectrol flat belts are not recommended for applications which involve belt twisting. Should an application require that a belt be twisted 90°, the length over which the twist occurs should be a minimum of 15 inches for a one inch wide belt.
- Gates Mectrol flat belts are not to be used in lat pull down machines or other machines in which belt twist is unrestricted.

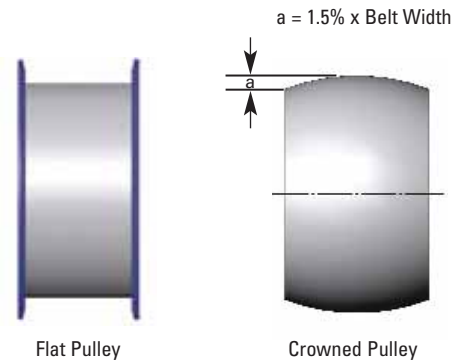

Materials		92A PU	85A PU	TPR
Service Temperature Range		-5° C to 70° C (23° F to 158° F)	-10° C to 60° C (14° F to 140° F)	-10° C to 70° C (14° F to 158° F)
Hardness, Shore A		92	85	90
Coefficient of Friction	Belt Material vs. Steel (dry)	0.5	0.7	0.5
	Urethane vs. Aluminum (dry)	0.5	0.6	0.5
	Belt Material vs. UHMWPE (dry)	0.2	0.4	0.2
	Nylon vs. Steel (dry)	0.2 to 0.4	0.2 to 0.4	0.2 to 0.4
	Nylon vs. UHMWPE (dry)	0.1 to 0.3	0.1 to 0.3	0.1 to 0.3



**Precision high strength, low stretch flat belts utilize tough urethane construction with specialty high carbon steel cord to lift heavy loads such as elevators.**

# Pulley Overview

---

Gates Mectrol manufactures a complementary line of timing pulleys. While industry standards do exist for most pulley groove geometries, each manufacturer has its own interpretation of those standards. For the longest belt life and quietest operation, it is recommended that the timing belts and pulleys be single-sourced so that the components are matched. Recognizing that any project may have different pulley style requirements, Gates Mectrol offers various pulley options:

- QuickShip pulley program – two to ten custom pulleys in seven working days
- Custom pulley program, additional features can be added

In addition to these pulley alternatives, Gates Mectrol offers both pulley bar stock and clamp plate programs, with many items in stock.

## QuickShip Pulley Program

Addresses basic pulley requirements:

- Seven working day lead time
- For basic pulley orders
  - Most common tooth counts in five different pitches
    - T5, AT5, T10, AT10 and H
- Quantities of two to ten

## Custom Pulley Program

This program is designed to meet your made-to-print custom pulley requirements.

- Unlimited design freedom
- Three raw material choices:
  - aluminum, steel or stainless steel

## Pulley Bar Stock and Clamp Plates

Gates Mectrol offers an in-stock program for both aluminum bar stock and clamp plates.



# QuickShip Pulley Program

A fast delivery program for standard featured pulleys for order volumes between 2 and 10 items.

Advantages include:

- Seven day lead time
- Reasonable design flexibility
- No engineering drawing signoff required

## Program Offering

Imperial Pitch	Standard Belt Widths					Standard Tooth Count																	
	1 inch	1.5 inch	2 inch	3 inch		12	14	16	18	20	22	24	26	28	30	32	34	36	40	44	48	72	
<b>H</b>	•	•	•	•			•	•	•	•	•	•	•	•	•	•		•					
Metric Pitch	10 mm	16 mm	25 mm	32 mm	50 mm																		
<b>T5</b>	•	•	•			•				•	•	•		•	•	•		•	•				
<b>T10</b>		•	•	•	•					•		•		•		•	•	•	•				
<b>AT5</b>	•	•	•						•	•	•	•	•	•	•		•	•				•	•
<b>AT10</b>		•	•	•	•				•	•	•	•	•	•	•	•		•	•	•	•		

- Aluminum body (no coatings)
- Standard hub sizes
  - Hub size is based on pitch and pulley diameter
  - Standard hubs can accommodate an optional set screw
- Standard flanges
  - Stamped steel/clear zinc plating
  - Flange size is based on pulley root and outside diameter
- Standard bore
  - Common decimal or metric bore diameters
  - H7 fit tolerance
- Standard keyways and set screws
  - Keyway dimensions are matched to standard bore sizes
  - Standard set screw locations:
    - One over keyway
    - Second optional location at 90 degrees to keyway
- Standard V-guides - K6, K13, A, O  
(see following page for dimensions)

# Custom Pulley Program

Pulleys can be customized to fit specific applications. Below are the options available:

## Material

- Aluminum
- Steel
- Stainless steel

## Flanges

- Zinc plated steel
- Stainless steel (for stainless steel pulleys)

## Coatings

- Clear anodize
- Black anodize
- Clear hardcoat
- Black oxide
- Electroless nickel

## Optional Pitches

- Most pitches can be supplied as zero backlash
- Typically used for precise positioning applications only

## Pulley Types

2F – Two Flanges

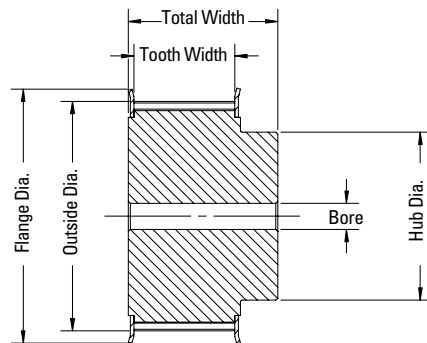

0F – No Flanges

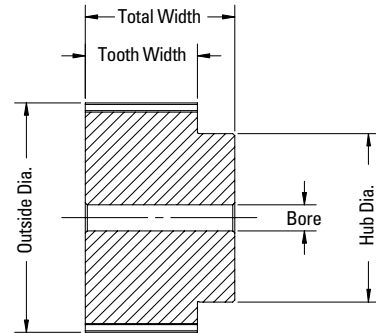

## V-Guides

For wider belts, and larger pulleys without flanges, one of the following V-guides is recommended for improved tracking:

For Metric Pitch Belts

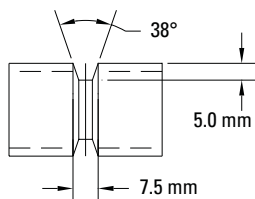

K6 Section

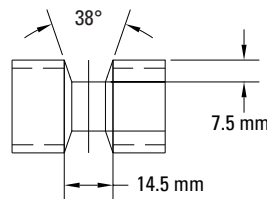

K13 Section

For Imperial Pitch Belts

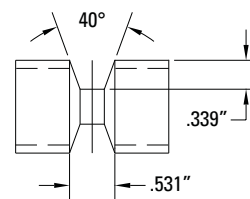

A Section

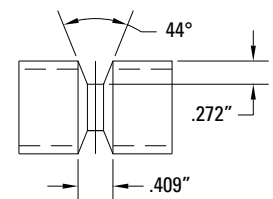

O Section



# Custom Pulley Program

## Standard Keyway Dimensions and Tolerances

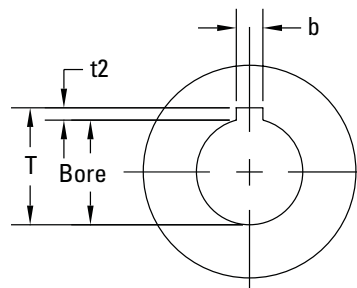
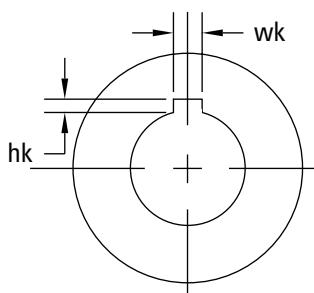

### Imperial Shaft Diameter

Over	Up to and Including	Width wk	Tolerance wk	Depth hk	Tolerance hk
	0.438	0.094		0.047	
0.438	0.563	0.125	+0.0030	0.063	
0.563	0.875	0.188	-0.0000	0.094	
0.875	1.250	0.250		0.125	
1.250	1.375	0.313	+0.0035	0.156	+0.015 -0.000
1.375	1.750	0.375	-0.0000	0.188	
1.750	2.250	0.500		0.250	
2.250	2.750	0.625		0.313	
2.750	3.250	0.750	+0.0040	0.375	
3.250	3.750	0.875	-0.0000	0.438	
3.750	4.500	1.000		0.500	
4.500	5.500	1.125	+0.0050	0.625	
5.500	6.500	1.500	-0.0000	0.750	

### Metric Shaft Diameter

Over	Up to and Including	Width b	Tolerance on b	*Depth t2	Tolerance t2
6	8	2	+0.060	1.0	
8	10	3	+0.020	1.4	
10	12	4	+0.078	1.8	+0.1
12	17	5	+0.030	2.3	-0
17	22	6		2.8	
22	30	8	+0.098	3.3	
30	38	10	+0.040	3.3	
38	44	12		3.3	
44	50	14	+0.120	3.8	
50	58	16	+0.050	4.3	
58	65	18		4.4	+0.2
65	75	20		4.9	-0
75	85	22	+0.149	5.4	
85	95	25	+0.065	5.4	
95	110	28		6.4	
110	130	32		7.4	
130	150	36	+0.180	8.4	+0.3
150	170	40	+0.080	9.4	-0

\* Metric keyway depths are specified from the bottom of the keyway to a line tangent to the bore at the keyway centerline.  
 $T = \text{Bore Diameter} + t_2$

# Pulley Bar Stock

## T5

# of Teeth	In Stock	Useable Width mm	Part Number
20	●	160	KT520.160A
24	●	160	KT524.160A
28	●	160	KT528.160A
32	●	160	KT532.160A
36	●	160	KT536.160A

## T10

# of Teeth	In Stock	Useable Width mm	Part Number
20	●	160	KT1020.160A
24	●	160	KT1024.160A
28	●	160	KT1028.160A
36	●	160	KT1036.160A

## AT5

# of Teeth	In Stock	Useable Width mm	Part Number
20	●	160	KAT520.160A
24	●	160	KAT524.160A
25	●	160	KAT525.160A
28	●	160	KAT528.160A
30	●	160	KAT530.160A
36	●	160	KAT536.160A
48	●	160	KAT548.160A
72	●	160	KAT572.160A

## AT10

# of Teeth	In Stock	Useable Width mm	Part Number
18	●	160	KAT1018.160A
20	●	160	KAT1020.160A
24	●	160	KAT1024.160A
28	●	160	KAT1028.160A
32	●	160	KAT1032.160A
36	●	160	KAT1036.160A

## H

# of Teeth	In Stock	Useable Width inch	Part Number
20	●	8.00	KH20.800A
24	●	8.00	KH24.800A
28	●	8.00	KH28.800A
36	●	8.00	KH36.800A

● = in stock

Material: Aluminum

Contact Gates Mectrol Applications Engineering for other pitches and tooth counts.



### To Order Metric Pitch Bar Stock

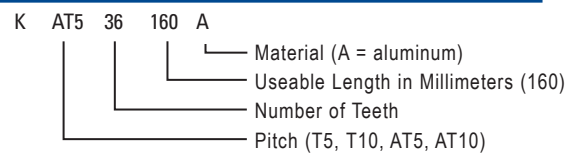

### To Order Imperial Pitch Bar Stock

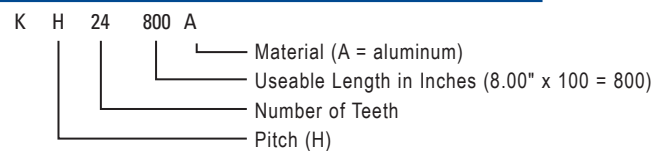

# Clamp Plates

Clamp plates are often used in motion control applications where one belt end is anchored by means of a clamp plate. The Gates Mectrol clamp plate engages eight teeth and has an end cutoff designed to prevent cord fatigue.

## AT5

Belt Width mm	In Stock	Length mm	B mm	Width mm	Hole Dia. mm	E mm	F mm	M mm	Thickness mm	Part Number
6		43	4	27.5	5.5	12.5	7.5	9	8	CGPAT56
10		43	4	31.5	5.5	16.5	7.5	9	8	CGPAT510
12		43	4	33.5	5.5	18.5	7.5	9	8	CGPAT512
16		43	4	37.5	5.5	22.5	7.5	9	8	CGPAT516
20		43	4	41.5	5.5	26.5	7.5	9	8	CGPAT520
25	●	43	4	46.5	5.5	31.5	7.5	9	8	CGPAT525
32	●	43	4	53.5	5.5	38.5	7.5	9	8	CGPAT532
50	●	43	4	71.5	5.5	56.5	7.5	9	8	CGPAT550
75		43	4	97.0	5.5	82.0	7.5	9	8	CGPAT575
100		43	4	122.0	5.5	107.0	7.5	9	8	CGPAT5100

## AT10

Belt Width mm	In Stock	Length mm	B mm	Width mm	Hole Dia. mm	E mm	F mm	M mm	Thickness mm	Part Number
16		85	7.5	46.5	9	26.5	10	17.5	15	CGPAT1016
20		85	7.5	50.5	9	30.5	10	17.5	15	CGPAT1020
25	●	85	7.5	55.5	9	35.5	10	17.5	15	CGPAT1025
32	●	85	7.5	62.5	9	42.5	10	17.5	15	CGPAT1032
50	●	85	7.5	80.5	9	60.5	10	17.5	15	CGPAT1050
75		85	7.5	106.0	9	86.0	10	17.5	15	CGPAT1075
100		85	7.5	131.0	9	111.0	10	17.5	15	CGPAT10100
150		85	7.5	181.0	9	161.0	10	17.5	15	CGPAT10150

## AT20

Belt Width mm	Length mm	B mm	Width mm	Hole Dia. mm	E mm	F mm	M mm	Thickness mm	Part Number
25	170	15	61.5	11	38.5	11.5	35	20	CGPAT2025
32	170	15	68.5	11	45.5	11.5	35	20	CGPAT2032
50	170	15	86.5	11	63.5	11.5	35	20	CGPAT2050
75	170	15	111.5	11	88.5	11.5	35	20	CGPAT2075
100	170	15	136.5	11	113.5	11.5	35	20	CGPAT20100
150	170	15	186.5	11	163.5	11.5	35	20	CGPAT20150

## H

Belt Width inch	In Stock	Length inch	B inch	Width inch	Hole Dia. inch	E inch	F inch	M inch	Thickness inch	Part Number
1.000	●	4.32	0.41	2.29	0.406	1.45	0.42	0.91	0.87	CGPH100
2.000		4.32	0.41	3.29	0.406	2.45	0.42	0.91	0.87	CGPH200

## HTD8

Belt Width mm	Length mm	B mm	Width mm	Hole Dia. mm	E mm	F mm	M mm	Thickness mm	Part Number
25	72	8	55.5	9	35.5	10	16	15	CGP8HTD25

## HTD14

Belt Width mm	Length mm	B mm	Width mm	Hole Dia. mm	E mm	F mm	M mm	Thickness mm	Part Number
25	126	14	60.5	11	37.5	11.5	28	22	CGP14HTD25
40	126	14	75.5	11	52.5	11.5	28	22	CGP14HTD40
55	126	14	91.0	11	68.0	11.5	28	22	CGP14HTD55
85	126	14	121.0	11	98.0	11.5	28	22	CGP14HTD85
100	126	14	136.0	11	113.0	11.5	28	22	CGP14HTD100
115	126	14	151.0	11	128.0	11.5	28	22	CGP14HTD115
170	126	14	206.0	11	183.0	11.5	28	22	CGP14HTD170

● = in stock

Material: Aluminum

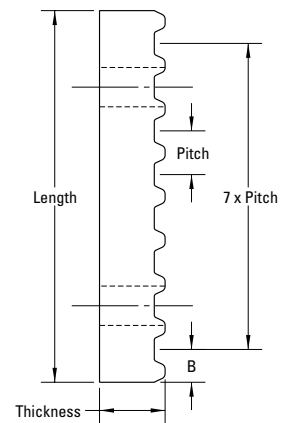
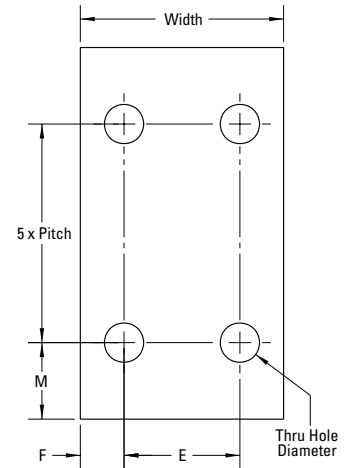



# Food Grade Belting Overview

---

Gates Mectrol's food grade belt product line represents the next generation of food processing. A stable base belt construction, multiple tooth configurations to choose from, a wide range of custom options and an innovative field joining system all serve to help meet your sanitation requirements.



## Advantages

---

- Easy to clean
  - Reduced risk of microbial contamination
  - 43% less surface area to clean than plastic modular belting
  - Appropriate for Clean In Place (CIP) cleaning protocol
- These blue belts are “green”
  - Significant cleaning water savings, cleaning labor savings and wastewater reduction
  - Water savings of 600 gallons per year for every foot of 24" wide plastic modular belting replaced
- Belt construction
  - Kevlar tension members stabilize belt properties under all lengths, loads and temperatures
  - No belt surface “sinks” over the tooth that can collect water and promote bacteria growth
- Innovative belt joining technology
  - Robust joining process eliminates callbacks



# Food Grade Belting – PosiClean®

**PosiClean** belting is an easy to clean, positive drive, replacement for plastic modular belt in the food processing industry. PosiClean belting has sealed Kevlar tension members to limit belt stretch and a tooth construction that extends the full belt width to better distribute torque.

## Application Characteristics

- Replacement for plastic modular belt
  - Easier cleaning
  - No hinges or pins to break and possibly contaminate product
  - Quieter operation
- Less labor and cleaning water than plastic modular belt
- Formulated for wash down environments
- Full width drive tooth distributes torque over full belt width making this belt appropriate for high load applications

## Features

- Direct replacement of most 2" and 1" plastic modular belt
- Smooth surface allows cleaning to microbiological level and clean-in-place process
- Sealed edges and tension members prevent ingress of microbes
- Kevlar tension members provide high strength, low stretch
- Tough polyurethane construction
  - Water and chemical resistant
  - Meets FDA material requirements for wet food contact
- Welded endless or spliced with stainless steel or plastic lacing
- USDA accepted for meat, poultry and dairy processing equipment

## PosiClean Specifications

Belt Options	PC20			PC10
	Standard	Hi Torque	Cold Temp	Standard
Designator	KV-FDA	HDK-FDA	HDK-R6	KV-FDA
Cords/Inch	2	4	4	2
Pitch (nominal)	2"	2"	2"	1"
Specific Belt Weight (lbs/ft/in)	0.078	0.078	0.078	0.059
Specific Belt Stiffness (lbs/inch/inch)	7400	11800	11800	7400
Min. Sprocket Dia.	3.76"	3.76"	3.76"	2.00"
Min. Back Bend Dia.	6"	6"	6"	3.5"
Service Temperature Range	-4° to 158° F	-4° to 158° F	-10° to 158° F	15° to 160° F
Coefficient of Friction				
Urethane vs. UHMW (dry)	0.53 to 0.69	0.53 to 0.69	0.54 to 0.69	0.30 - 0.40
Urethane vs. Stainless Steel (dry)	0.74 to 0.94	0.74 to 0.94	0.64 to 0.68	0.50 - 0.60
Color (B=Blue, W=White)	B	B	B	B
Min. and Max. Width	8"/36"	8"/36"	8"/36"	6"/36"
<b>Fastening Options</b>				
Max. Allowable Tension (lbs per inch width) <sup>(1)</sup>				
Factory Weld (Finger Length PC20 - 3.35", PC10 - 3.02")	30	51	50	30
Field Weld (Finger Length 25 mm)	22	39	35	N/A
Field Weld Straight Cut	15	26	24	19
PosiLace™	13	13	13	N/A
Flexco® UX1SS Clipper® Wire Hooks	15	26	23	15
Flexco® APF150 Alligator® Plastic Rivet	15	26	23	N/A
Flexco® APF100 Alligator® Plastic Rivet	N/A	N/A	N/A	15
Flexco® RS125 Alligator® Ready Set™ Staple	15	26	23	N/A
Flexco® RS62 Alligator® Ready Set™ Staple	N/A	N/A	N/A	15

(1) Max allowable set as the lower of 25% yield strength or 2% stretch of weld or splice

## Food Grade Belt - Slit Width Tolerance

Up To and Including 4"	>4" to 12"	>12" to 16"	>16" to 20"	>20" to 24"	>24" to 28"	>28" to 32"	>32"
+0/- .100"	+0/- .120"	+0/- .125"	+0/- .160"	+0/- .190"	+0/- .225"	+0/- .240"	+0/- .255"

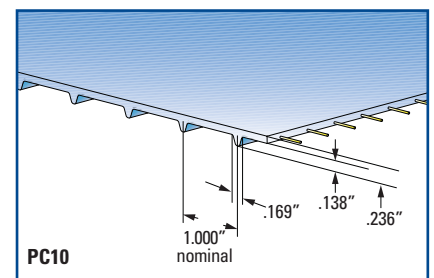
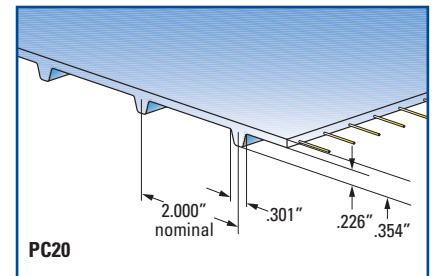

# Food Grade Belting – CenterClean™

**CenterClean40** product has drive teeth only in the center three inches of the belt and a pitch length of 40mm (1.57"). The lack of extended teeth makes this belt appropriate for self-tracking and troughing applications as well as general processing.

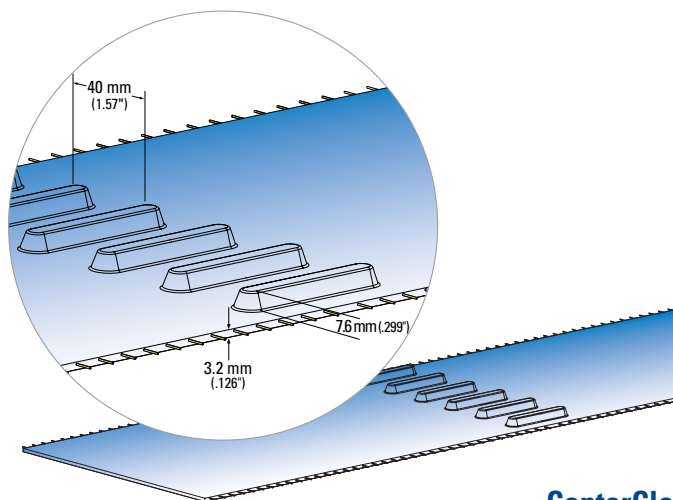

## Application Characteristics

- Formulated for wash down environments
- Troughing conveyor
- Self-centering design

## Features

- Smooth surface allows cleaning to microbiological level and clean-in-place process
- Sealed edges and tension members prevent ingress of microbes
- Kevlar tension members provide high strength, low stretch
- Tough polyurethane construction
  - Water and chemical resistant
  - Meets FDA material requirements for wet food contact
- Welded endless or spliced with stainless steel or plastic lacing
- USDA accepted for meat, poultry and dairy processing equipment



CenterClean belts are constructed with flexible urethane and sealed Kevlar tension members. This construction allows CenterClean belts to be troughed or run on small diameter pulleys with minimal belt stretch.

## CenterClean Specifications

	CC40
<b>Belt Specifications</b>	<b>Standard</b>
Cords/inch	2
Pitch (nominal)	40 mm (1.57")
Specific Belt Weight (lbs/ft/in)	0.078
Specific Belt Stiffness (lbs/inch/inch)	7400
Min. Sprocket Dia.	3.9"
Min. Back Bend Dia.	6"
Service Temperature Range	15° to 160° F
Coefficient of Friction	
Urethane vs. UHMW (dry)	0.30 - 0.40
Urethane vs. Stainless Steel (dry)	0.50 - 0.60
Color (B=Blue, W=White)	B
Min. and Max. Width	8"/36"
Tracking Lane	Yes
<b>Fastening Options</b>	
Max. Allowable Tension (lbs per inch width) <sup>(1)</sup>	
Factory Weld (Finger Length 1")	35
Field Weld (Finger Length 1")	35
Field Weld Straight Cut (overlap)	30
PosiLace™	N/A
Flexco® UX1SS Clipper® Wire Hooks	N/A
Flexco® APF150 Alligator® Plastic Rivet	20
Flexco® APF100 Alligator® Plastic Rivet	N/A
Flexco® RS125 Alligator® Ready Set Staple	20
Flexco® RS62 Alligator® Ready Set Staple	N/A

(1) Max allowable set as the lower of 25% yield strength or 2% stretch of weld or splice

## Food Grade Belt - Slit Width Tolerance

Up To and Including 4"	>4" to 12"	>12" to 16"	>16" to 20"	>20" to 24"	>24" to 28"	>28" to 32"	>32"
+0/-.100"	+0/-.120"	+0/-.125"	+0/-.160"	+0/-.190"	+0/-.225"	+0/-.240"	+0/-.255"

# Food Grade Belting – FlatClean™

**FlatClean** is a polyurethane flat belt reinforced with Kevlar tensile members. The combination of a non-fraying polyurethane jacket material with sealed low-stretch tensile members dramatically increases belt life. Increased belt life minimizes production down time.

## Features

- Sealed edges and tension members prevent ingress of microbes
- Kevlar tension members provide high strength, low stretch and are cut and abrasion resistant
- Smooth surface and non-fraying edges allow cleaning to a microbiological level
- Welded endless or spliced with stainless steel lacing
- Tough polyurethane construction
  - Water and chemical resistant
  - Meets FDA material requirements for wet food contact
- USDA accepted for meat, poultry and dairy processing equipment

## Application Characteristics

- Wash down environments
- Troughing

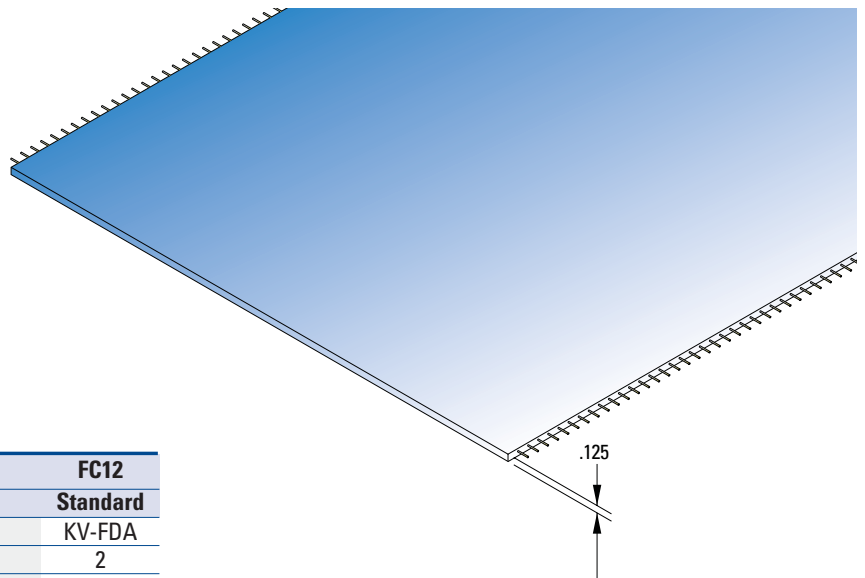

## FlatClean Specifications

	FC12
<b>Belt Options</b>	<b>Standard</b>
Designator	KV-FDA
Cords/Inch	2
Pitch (nominal)	
Specific Belt Weight (lbs/ft/in)	0.065
Specific Belt Stiffness (lbs/inch/inch)	7400
Min. Pulley Dia.	2.00"
Min. Back Bend Dia.	3"
Service Temperature Range	-4° to 158° F
Coefficient of Friction	
Urethane vs. UHMW (dry)	0.53 to 0.69
Urethane vs. Stainless Steel (dry)	0.74 to 0.94
Color (B=Blue, W=White)	B
Min. and Max. Width	8"/36"
<b>Fastening Options</b>	
Max. Allowable Tension (lbs per inch width) <sup>(1)</sup>	
Factory Weld (Finger Length 3.35")	30
Field Weld (Finger Length 1")	22
PosiLace™	N/A
Flexco® UX1SS Clipper® Wire Hooks	15
Flexco® APF150 Alligator® Plastic Rivet	15
Flexco® RS62 or RS125 Alligator® Ready Set™ Staple	15

(1) Max allowable set as the lower of 25% yield strength or 2% stretch of weld or splice



## Food Grade Belt - Slit Width Tolerance

Up To and Including 4"	>4" to 12"	>12" to 16"	>16" to 20"	>20" to 24"	>24" to 28"	>28" to 32"	>32"
+0/- .100"	+0/- .120"	+0/- .125"	+0/- .160"	+0/- .190"	+0/- .225"	+0/- .240"	+0/- .255"



# Food Belt Fastening Options

The ability to thermally weld two prepared belt ends together allows for a seamless finish that minimizes bacteria growth and is easy to clean.

## Welding Options

**Factory Weld** – uses a 78 mm or 85 mm long tapered finger and a platen press weld. The shear strength provided by the overlapping tension members provides for the highest maximum allowable belt tension per inch. (See PosiClean Belt Specifications for maximum allowable tension.)



Finger Splice

**PosiWeld™ Field Welder** – uses a straight cut belt end at the tooth to achieve a maximum allowable tension of 15 lbs/in that is appropriate for light and medium duty applications.

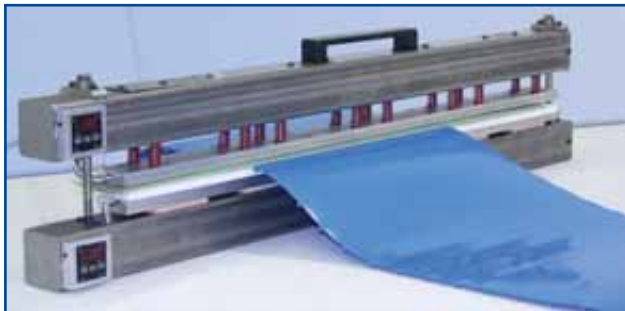

PosiWeld™ Field Welder

This lightweight, portable platen type welder is designed to join food grade belting using heat and pressure to develop a robust weld.

Welder advantages:

- Light enough for one person to handle
- Uses 120V power
- Requires no water or compressed air
- Cycle time of less than one hour

**PosiLace™**  
Pin fastened method meets low to medium load requirements without welding to achieve the maximum allowable tension of 13 lbs/in.



PosiLace™

Belt ends are prepared at the factory and the belt is joined by a single pin inserted after the belt is placed in position on the equipment.

This “living” fastening solution allows for removal and replacement of the belt as often as desired – without ever having to weld.

## Other Mechanical Fasteners

From wire hooks to metal staples, standard conveyor fasteners are available for those situations when quick assembly/disassembly is required.



Wire Hooks



Plastic Rivets



Metal Staples

# Food Belt Fabrication and Installation

Gates Mectrol offers a full range of fabrication services, including **flights** and **sidewalls** to assist in transporting product up an incline as well as **V-guides** for tracking purposes.

## Flights

- High strength, low stretch for long life
- 1", 1.5", 2", 3", 4" and 6" heights
- Full width, insets, gaps
- Thickness: 5 mm

## Sidewalls

- Height range: 1.4" to 4.0"
- Wall thickness: 2mm
- Baseless sidewall
- Minimum distance to profile: 0.25"
- Minimum belt length: 57"

## V-Guides

- Contact our Applications Engineering department for availability of other V-guides

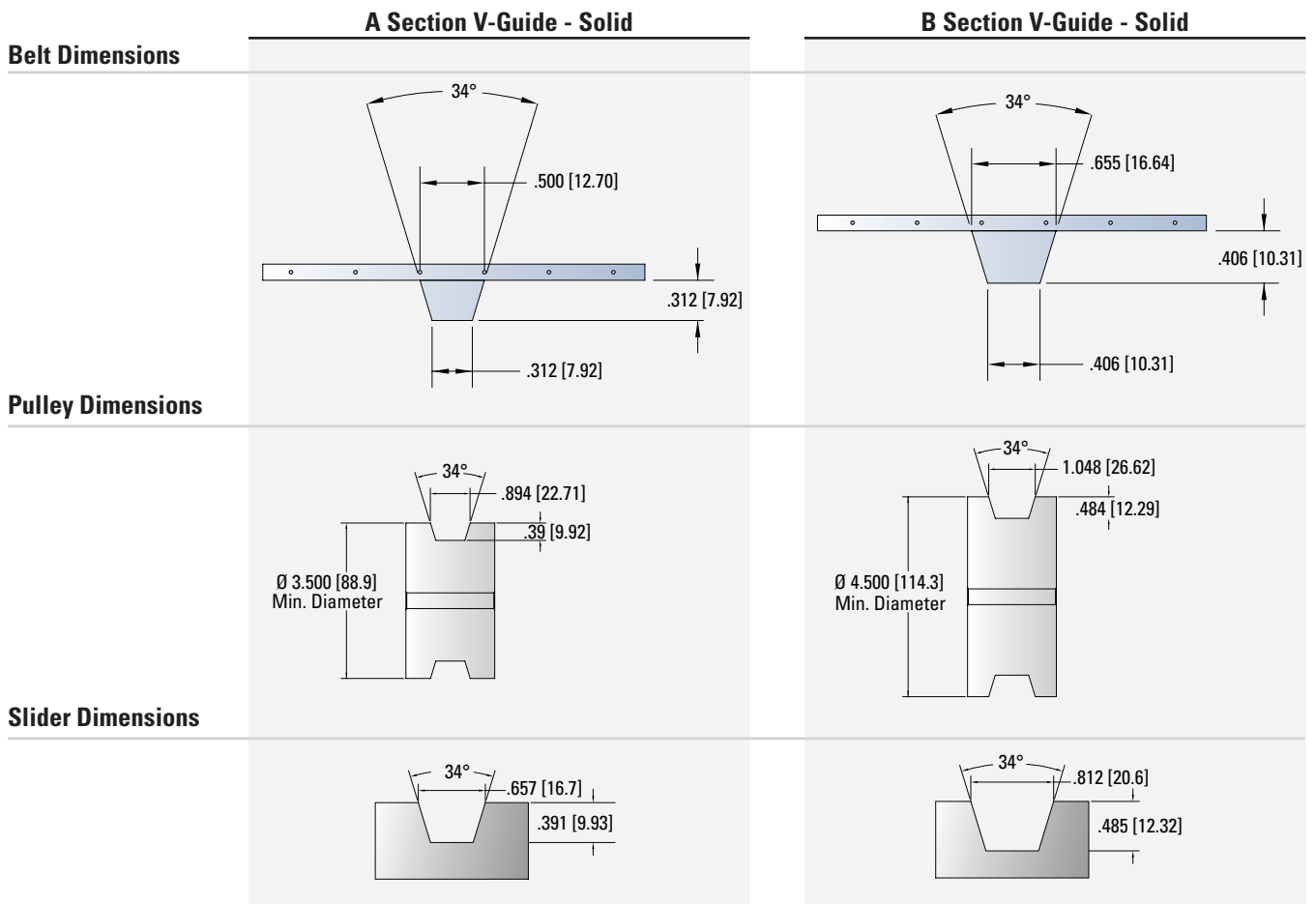

# Food Belt Sprockets and Support

## PosiClean Sprocket Specifications

Number of Teeth		PC20				PC10					
		6	8	10	12	6	8	10	12	20	
Nom. Outside Diameter	inch	3.7	4.9	6.2	7.5	1.9	2.5	3.2	3.8	6.4	
	mm	94	126	158	189	48	64	81	97	163	
Nominal Width	inch	1.3	1.3	1.3	1.3	1	1	1	1	1	
	mm	32	32	32	32	25.4	25.4	25.4	25.4	25.4	
Available Bore Sizes	Imperial Sizes	Square, in	1.5	1.5	1.5	1.5	N/A	N/A	1.5	1.5	1.5
		Round*, in	1	1	N/A	N/A	1	1	1	N/A	N/A
	Metric Sizes	Square, mm	40	40	40	40	N/A	N/A	40	40	40
		Round*, mm	30	30	N/A	N/A	N/A	N/A	25	N/A	N/A
Material		UHMW-PE				UHMW-PE					

\* Imperial keyway sizes on round bores conform to ANSI standard B17.1 - 1967 (R1989) metric keyway sizes conform to BS 4235: Part 1: 1972 (1986)



PosiClean Sprockets

## PosiClean Sprocket and Support Guidelines

Belt Width	inch	6	9	12	15	18	21	24	27	30	36
Min. No. Sprockets (Max. 5" spacing center to center)		3	3	4	4	5	6	6	7	7	9
No. of Sprockets for max. allow. tension (Max. 3" spacing center to center)		3	4	5	6	7	8	9	10	11	13
Min. No. Carryway Supports (6" spacing center to center)		2	3	3	4	4	5	5	6	6	7

## CenterClean Sprocket Specifications

Number of Teeth	CC40										
		8	9	10	11	12	13	15	16	17	20
Nom. Outside Diameter	inch	3.9	4.4	4.9	5.4	5.9	6.4	7.4	7.9	8.4	9.9
	mm	99	112	124	137	150	163	188	201	213	251
Nominal Width	inch	6.5	6.5	6.5	6.5	6.5	6.5	6.5	6.5	6.5	6.5
	mm	165	165	165	165	165	165	165	165	165	165
Imperial Square Bore - Dimension	inch	1.5	1.5	1.5	1.5	1.5	1.5	1.5	1.5	1.5	1.5
Material	UHMW-PE										



CenterClean Sprockets

## CenterClean Carryway Support Guidelines

Distance Between Parallel Wear Strips Guiding Belt Teeth, Dim. A	3.15"
Distance Between Parallel Wear Strips Not Guiding Belt Teeth, Dim. B	4" - 6"

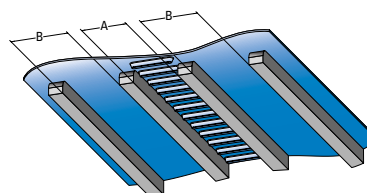

# Technical Design Tools Online

---

Gates Mectrol's belt design tools make selecting the right belt for your application easy anytime: <http://apps.gatesmectrol.com/applications/>

Gates Mectrol offers online design tools for calculating all types of urethane timing belt applications.

These design tools are, by far, industry state-of-the-art, offering the most comprehensive, easy to use and accurate calculations available.

For linear and rotary positioning applications, synchronous conveying or power transmission, simply enter all of your known parameters, and these programs will guide you through step-by-step calculations, resulting in the selection of the most appropriate belt for your application.

Included with your output will be information which is "total system" inclusive, providing necessary data for selecting all related drive components, as well as for programming electronic controls.

Log on to [www.gatesmectrol.com](http://www.gatesmectrol.com) today, and register for instant access to the industry's best calculation tools available.

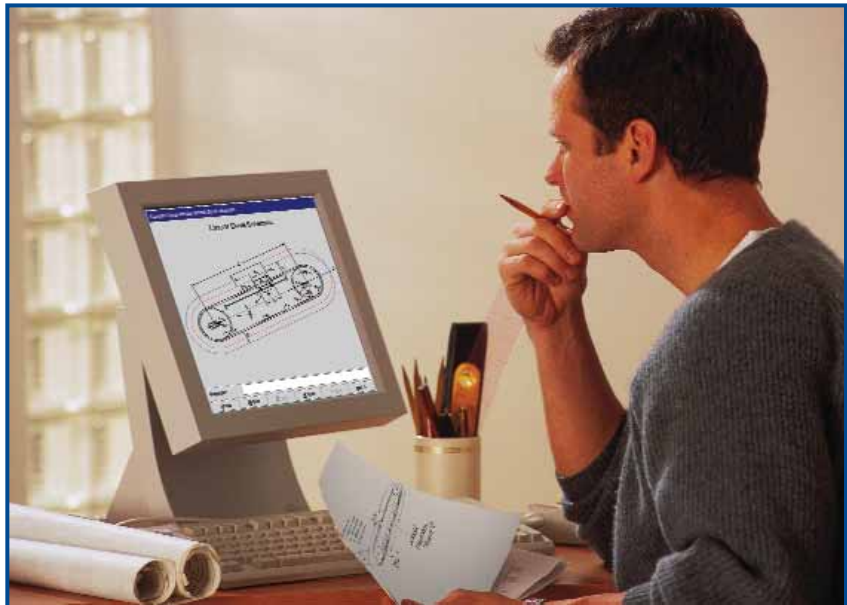

>> To access our design tools online visit <http://apps.gatesmectrol.com/> or call **1-800-394-4844**

# Facilities



Headquarters

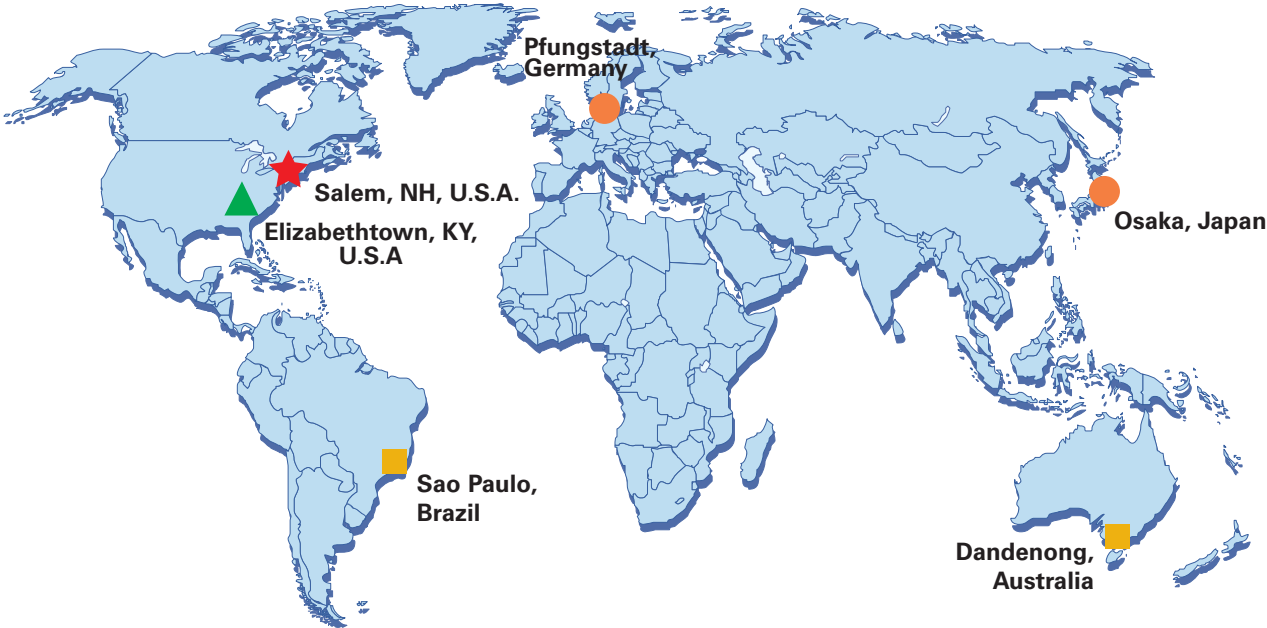

- ★ Headquarters, Sales & Manufacturing
- Sales & Manufacturing
- Sales
- ▲ Manufacturing





**USA  
CORPORATE HEADQUARTERS**

Gates Mectrol, Inc.  
9 Northwestern Drive  
Salem, NH 03079, U.S.A.  
Tel. +1 (603) 890-1515  
Tel. +1 (800) 394-4844  
Fax +1 (603) 890-1616  
email: [contact@gatesmectrol.com](mailto:contact@gatesmectrol.com)

**EUROPE**

Gates Mectrol GmbH  
Werner von Siemens Strasse 2  
64319 Pfungstadt, Germany  
Tel. +49 (0) 6157-9727-0  
Fax +49 (0) 6157-9727-272  
email: [info@gatesmectrol.de](mailto:info@gatesmectrol.de)

**MEXICO**

Gates de Mexico S.A. de C.V.  
Cerrada de Galeana 5  
Fracc. Industrial La Loma  
Tlalnepantla, 54060, Mexico  
Tel. +52 (552) 000-2700  
Fax +52 (552) 000-2701  
email: [em1009@gates.com](mailto:em1009@gates.com)

**AUSTRALIA**

Gates Australia Pty Ltd.  
1-15 Hydrive Close  
South Dandenong, Victoria 3175, Australia  
Tel. +61 (3) 9797-9688  
Fax +61 (3) 9797-9600  
email: [southpacsales@gates.com](mailto:southpacsales@gates.com)

**SOUTH AMERICA**

Gates Do Brazil Ind. Com. Ltda  
Av. Santa Maria, 600  
Jacarei, SP 12328-320, Brazil  
Tel. +55 (11) 3848-8122  
Fax +55 (11) 3848-8170  
email: [gatesmkt@gatesbrasil.com.br](mailto:gatesmkt@gatesbrasil.com.br)

**ASIA**

Gates Unitta Asia Company  
4-26 Sakuragawa 4-chome,  
Naniwa-KU  
556-0022 Osaka, Japan  
Tel. +81 (6) 6563-1266  
Fax +81 (6) 6563-1267

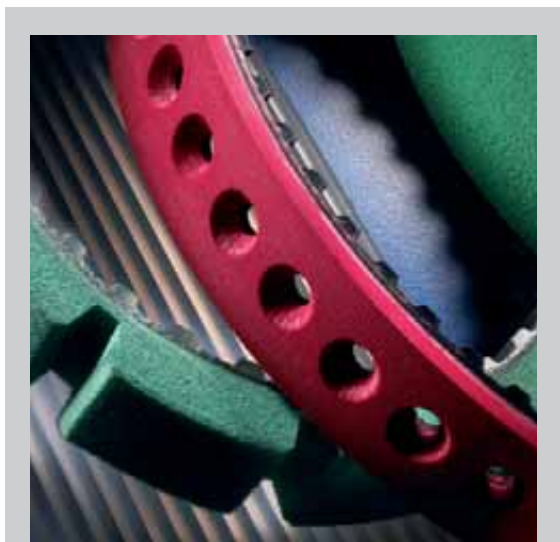
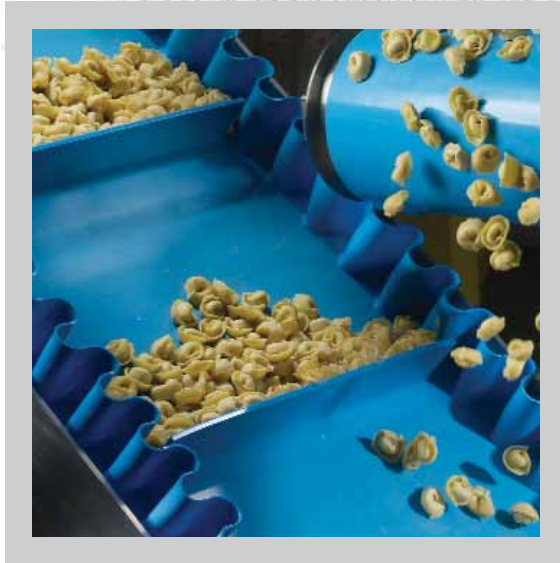

Gates Mectrol, Synchro-Power and PosiClean are registered trademarks and CenterClean, FlatClean, PosiWeld and PosiLace are trademarks of Gates Mectrol Incorporated. All other trademarks used herein are the property of their respective owners.

© Copyright 2011 Gates Mectrol Incorporated.  
All rights reserved. 5/11

GM\_UTB\_11\_US